

# Table of Contents

---

Roof Construction Techniques: Pro's and Con's .....	2
Trusses: Special Benefits for Architects and Engineers .....	4
Special Benefits for Contractors and Builders .....	5
Special Benefits for the Owner.....	5
How Does A Truss Work?.....	6
Typical Framing Systems.....	8
Gable Framing Variations .....	11
Hip Set Framing Variations .....	13
<b>Additional Truss Framing Options</b>	
Valley Sets .....	15
Piggyback Trusses .....	17
Typical Truss Configurations.....	18
Typical Truss Shapes.....	20
<b>Typical Bearing / Heel Conditions</b>	
Exterior Bearing Conditions.....	21
Crushing at the Heel .....	22
Trusses Sitting on Concrete Walls .....	22
Top Chord Bearing.....	23
Mid-Height Bearing .....	23
Leg-Thru to the Bearing.....	23
Tail Bearing Tray.....	24
Interior Bearing Conditions .....	24
Typical Heel Conditions.....	25
<b>Optional End Cosmetics</b>	
Level Return.....	25
Nailer .....	25
Parapet.....	26
Mansard .....	26
Cantilever.....	26
Stub .....	26
Bracing Examples .....	27
Erection of Trusses .....	29
Temporary Bracing .....	30
Checklist for Truss Bracing Design Estimates .....	32
Floor Systems .....	33
<b>Typical Bearing / Heel Conditions for Floor Trusses</b>	
Top Chord, Bottom Chord, and Mid-Height Bearing.....	34
Interior Bearing Conditions .....	35
Ribbon Boards, Strongbacks and Fire Cut Ends .....	36
Steel Trusses .....	37
Ask Charlie V. ....	38
Charlie's Advice on Situations to Watch Out for in the Field.....	41
Glossary of Terms.....	42
Appendix - References.....	48

# Builders, Architects and Home Owners today have many choices about what to use in roof and floor systems

**Traditional Stick Framing** – Carpenters take 2x6, 2x8, 2x10 and 2x12 sticks of lumber to the job site. They hand cut and fit this lumber together into a roof or floor system.

**Timber Frame** – Craftsmen assemble timbers, joinery and braces together to form a self-supporting skeleton structure.

**Engineered Wood Products** – I-Joists, Glulam, and LVL (laminated veneer lumber) wood products are shipped to the jobsite, cut to fit, and made into beams for the floor system, or into ridge beams and sloping joists for the roof system.

**Truss Systems** – in two primary forms:

- **Metal Plate Connected Wood Trusses** – Engineered trusses are designed and delivered to the jobsite with a truss placement plan. Trusses are quickly erected and braced onsite.
- **Steel Trusses** – Light gauge steel trusses are designed and delivered to the jobsite with a truss placement plan. Trusses are lightweight, able to be quickly erected and braced onsite.

Each method has advantages and disadvantages. In this book we will look at those pros and cons, and assist you in identifying which method is best for your situation. We hope to be able to offer you strengths for each system that can help you sell the value-added difference in the product you choose, as well as help you gain a better understanding of the roof systems themselves, with “real world” advice on framing techniques and issues.

## Pros

## Cons

### Stick Framing

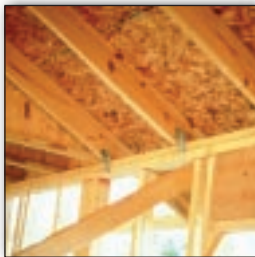

Lowest cost for materials. If you have the time and the skilled labor required.

If trusses cannot be delivered to the jobsite, conventional framing may be your only alternative.

Slow to install and requires skilled labor.

May not be accepted by the building department, as it is not an engineered product.

Requires scarce large lumber sizes (2x8, 2x10)

Smaller span capability.

High jobsite waste.

### Timber Frame



Creates handsome exposed timber-frame structures.

Requires skilled labor.

Difficult to run ductwork, wiring, pipes through.

Slow to install and frame in.

Hard to insulate

## Engineered Wood Products



### Pros

I-Beams are suitable for steep sloping ceilings.

Trim-able ends on floors, great for angled or rounded walls.

Engineered product with uniform quality.

Glulam and Laminated Veneer Lumber make strong beam material.

### Cons

Difficult to run ductwork, wiring, pipes through.

Limited use in complicated roof lines, coffered ceilings, etc.

May require special connections.

## Wood Trusses



Lowest overall cost.

Fast to install.

Requires ordinary tools and doesn't require skilled labor to install.

Virtually any roof and ceiling is possible.

Engineered product.

No job site waste.

You will want to plan things in advance. You'll need a set of plans for the structure, and your walls should be close to where they're supposed to be.

## Steel Trusses



Lightweight and stiff, so installing is easy and fast.

May be preferred in light commercial / industrial settings for fire rating.

Straight ceilings for ceiling attachment.

Virtually any roof and ceiling is possible.

Engineered product.

More expensive than metal connector plate wood trusses.

If not analyzed/ designed by a leading industry software program, the joint connections may be suspect.

# Trusses: Special Benefits for Architects and Engineers

Trusses bring virtually unlimited **architectural versatility**, providing simple solutions to complex designs and unusual conditions without inhibiting building design freedom. Using trusses, you have complete flexibility in interior room arrangements, too. Using Alpine's proprietary VIEW software, truss designers can produce engineered shapes that satisfy virtually any aesthetic and functional specification by the building design professional.

Trusses are an **engineered and tested** product. There are nationally recognized standards for truss design and manufacturing of metal plate connected wood trusses. These standards have been adopted by major model building codes. This ensures a quality product. Alpine Professional Engineers are committed to providing the highest quality, cost efficient structural products for your clients.

Trusses span longer than conventional framing, so you have **more open space** to work with in the interior.

Truss manufacturers using Alpine software are available for consultation when special framing situations arise.

Wood trusses connected with metal plates enjoy an outstanding record of **more than 35 years of proven performance and durability**.

State of the art truss design software allows manufacturers to design them to be:

- Hurricane-resistant, and/or
- Withstand heavy snow loads, and/or
- Support storage areas above the ceiling.

You can get a **one- or two-hour fire rating** with trusses using the FR-Quik System.

**FR-Systems**  
Fire Resistance Assemblies  
Fire Resistance Assemblies with Wood Trusses  
Evaluated by National Evaluation Service, NER-392

**FR-System 1**  
1 Hour Floor-Ceiling Roof-Ceiling Assembly without insulation

**FR-System 2**  
2 Hour Floor-Ceiling Roof-Ceiling Assembly with insulation

**FR-System 3**  
1 Hour Floor-Ceiling Assembly with Insulation shown in both triangular and parallel chord truss applications

Other Assemblies  
**UL L528 & L 529**  
1 Hour Fire Resistive Assemblies

L528 is a one-hour fire resistance rated floor/ceiling assembly listed by Underwriters Laboratories, Inc. (UL) for the Truss Plate Institute (TPI). The assembly requires furring channels wired perpendicular to the truss bottom chord and 5/8" thick USG Type C gypsum wallboard screwed to the channels.  
L529 is similar, except that the ceiling is a metal grid system with gypsum panels.  
Full specifications are available from UL or TPI.



## Special Benefits for Contractors and Builders

---

Trusses go up faster and easier, with less skilled labor requirements, no matter how complicated the roof or ceiling is.

Trusses put you under roof faster, which helps in drawing construction loans.

The use of preassembled components generates less waste at the jobsite. This improves safety and reduces cleanup costs. On-site losses from mis-cutting, theft and damage are virtually eliminated.

Trusses are built in a computer-aided manufacturing environment to assure accuracy and quality.

Industry standards for manufacturing and handling assure code-compliance. Building departments recognize these standards and respect the software used to design trusses. While many building departments are wary about inspecting

• conventional framing, sealed truss designs are easily inspected.

• Trusses are lightweight and easy to install, requiring only normal construction tools.

• The wide nailing surface of 4x2 floor trusses safely speeds deck and flooring installation.

• Expenses are accurately controlled because truss costs can be predetermined.

• Open web design allows easy installation of plumbing, electrical wiring and heating/cooling ductwork.

• Trusses are available locally for fast delivery. More than 550 truss manufacturers throughout the United States and Canada are backed by the expertise of Alpine Engineered Products, Inc.

## Special Benefits for the Owner

---

The owner can enjoy peace of mind, knowing that the trusses have been professionally engineered and quality manufactured for the specific job.

The resiliency of wood provides a floor system that is comfortable.

Wood is a natural insulator because it is composed of thousands of individual cells, making it a poor conductor of heat and cold.

Roof truss details such as tray, vaulted or studio ceilings improve the appearance and comfort of homes, offices, churches and commercial buildings.

• Floor trusses can conceal mechanical services, leaving a clear plane for ceiling installations. This is ideal for finished rooms in a lower level.

• Trusses provide clear spans so interior walls can be moved easily during remodeling or when making additions. It is very economical to remodel homes with trusses, versus frame houses.



# How Does a Truss Work?

A truss is a frame that supports loads by efficiently transferring its forces to end supports. While stick framing might use larger 2x8, 2x10, etc. members (which are expensive and hard to find without going into old growth forests), and might require either additional beams or interior load bearing walls, trusses can span a longer distance without additional supports, while using less expensive and more plentiful 2x4 members, usually arranged in intersecting triangles.

- Trusses can span up to approximately 90', although very long truss spans are more challenging to deliver, erect, brace and install properly. While longer trusses may be "wobbly" as they are lifted off of the ground and onto the bearing walls, once they are properly braced, the truss system is extremely strong.

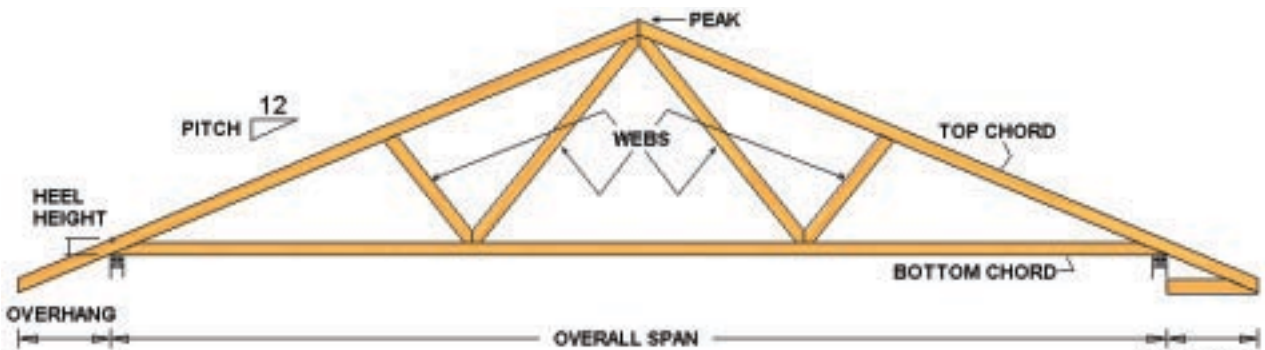

Most truss manufacturers utilize sophisticated truss design software that is capable of designing the truss system as well as the truss itself.

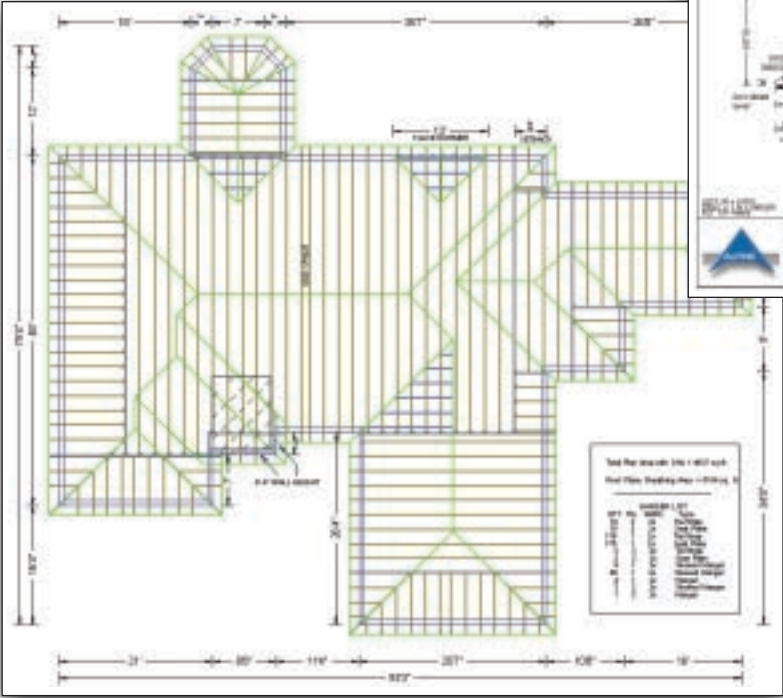
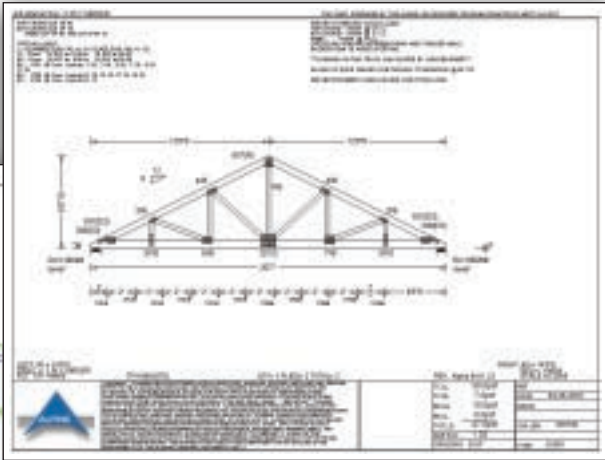

The truss designer will work from a set of plans, first creating a truss placement plan, and then designing each truss in the system.

The job is manufactured and delivered to the jobsite, where the contractor / builder erects them and then quickly braces them.



*Cutting the lumber*



*Manufacturing the trusses*



*Delivering a truckload of trusses*



*Erecting the trusses on the jobsite*

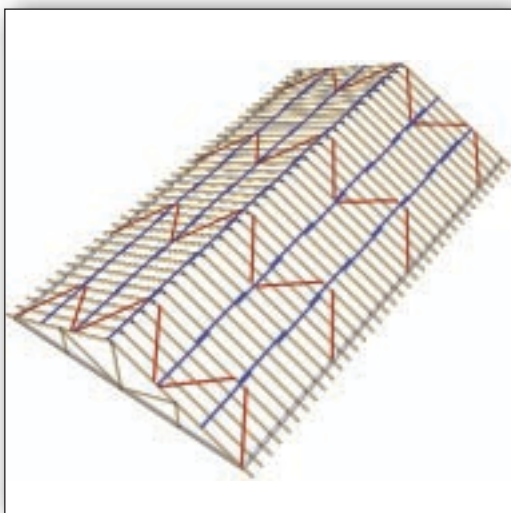

*Temporary bracing system*



*Permanent bracing system*

## Typical Framing Systems

Truss framing systems, and the names associated with them, vary all over the country and throughout the world. No matter how they are framed or what they are called, though, truss systems easily provide tremendous flexibility in the look of the roof system.

- The illustrations below are designed to help you visualize typical framing systems, looking at:
  - A truss placement plan,
  - The overall 3D look of the roof planes in that roof system, and
  - 3D view of the framing system of trusses.

### Gable

(\* See also – Gable framing variations)

The most basic (and least expensive) of roofs, a gable roof rises vertically on the shorter ends of the building, with sloping planes on either side, which meet in the middle. In our example you'll

- find a gable frame on either end, each supported by the continuous wall underneath it, and common trusses in between, each of which spans from one wall to the other.

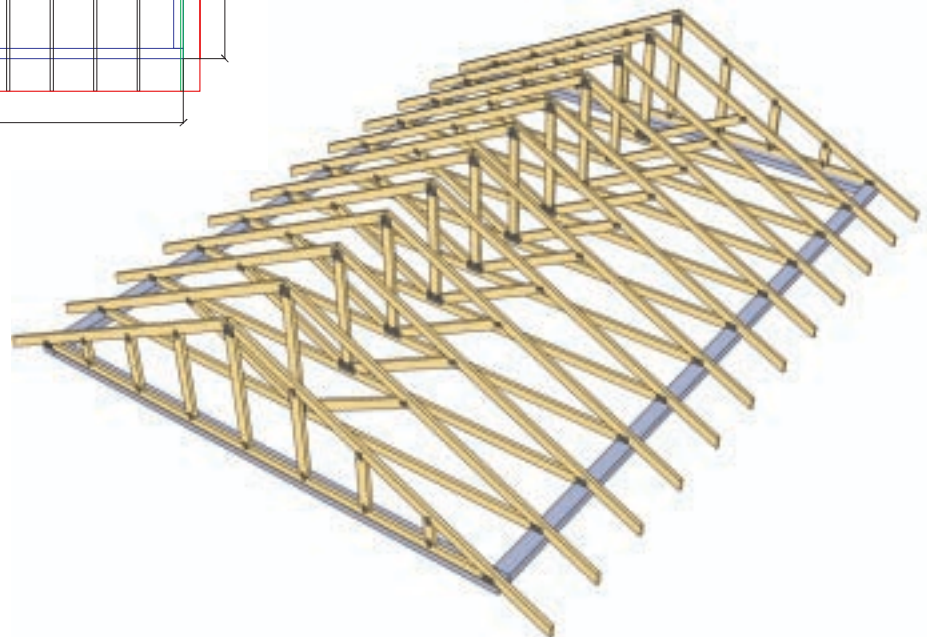
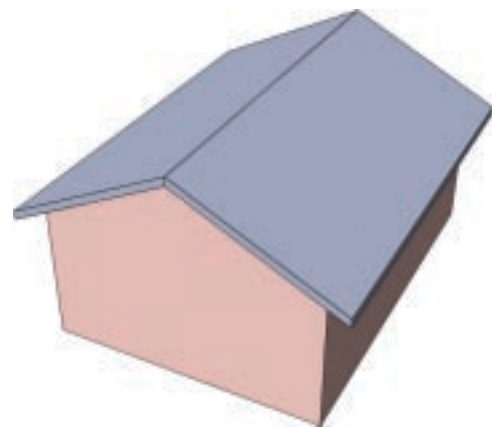
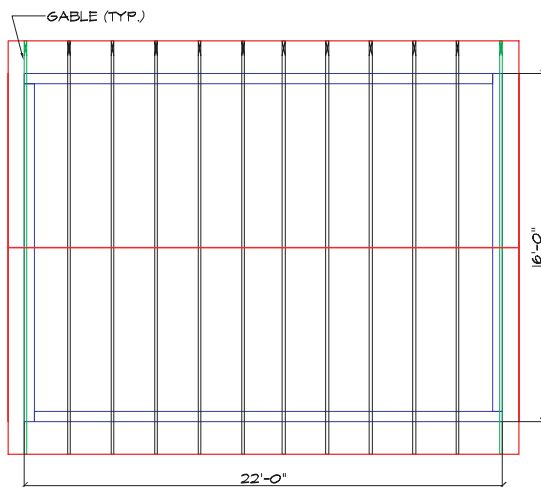

This roof system could have a sloping ceiling or tray ceiling, if desired.



---

## Hip Set

---

( \* See also – Hip set framing variations )

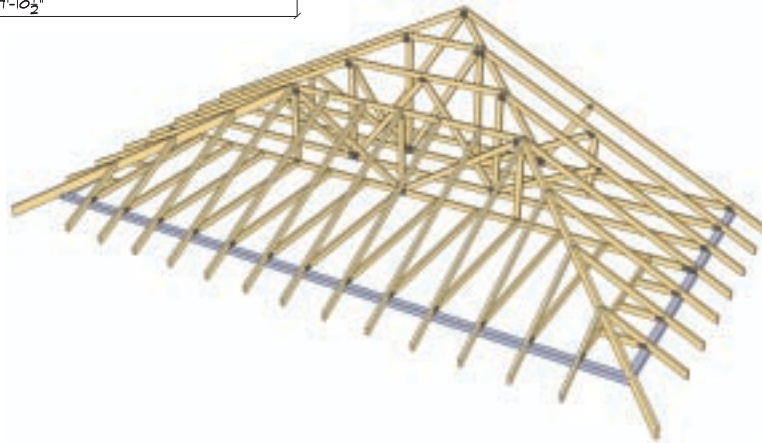
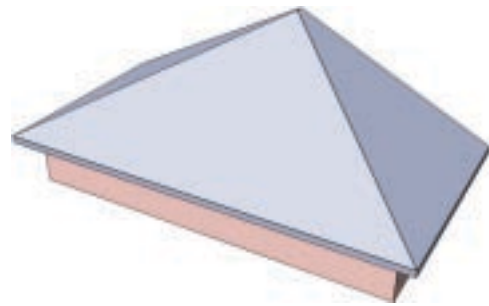
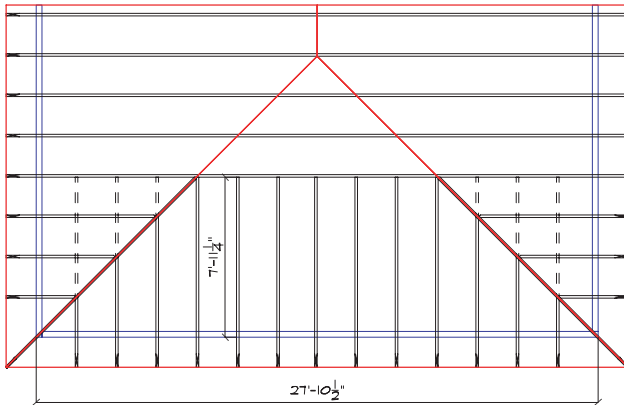

---

## Dutch (Boston) Hip Set

---

Notice the vertical rise in the middle of the hip set end plane.

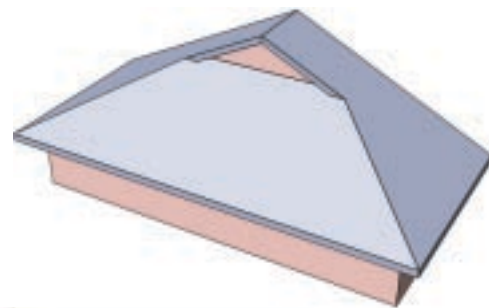
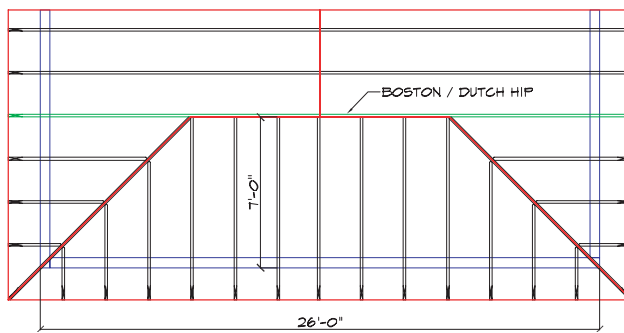

## Tudor Hip

A tudor hip provides some interesting sloping planes at either end, and is generally less expensive to build than a full hip set.

TUDOR GABLE (TYP.)

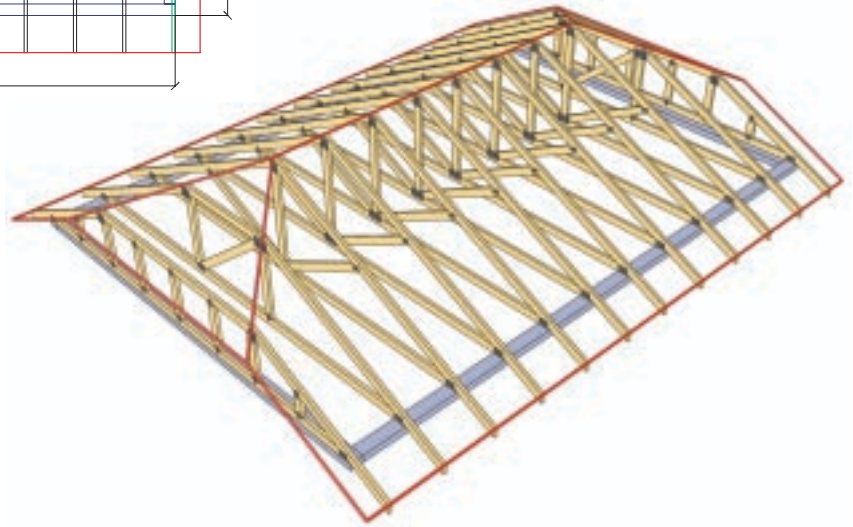
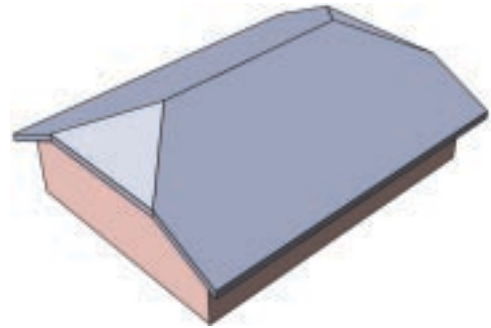
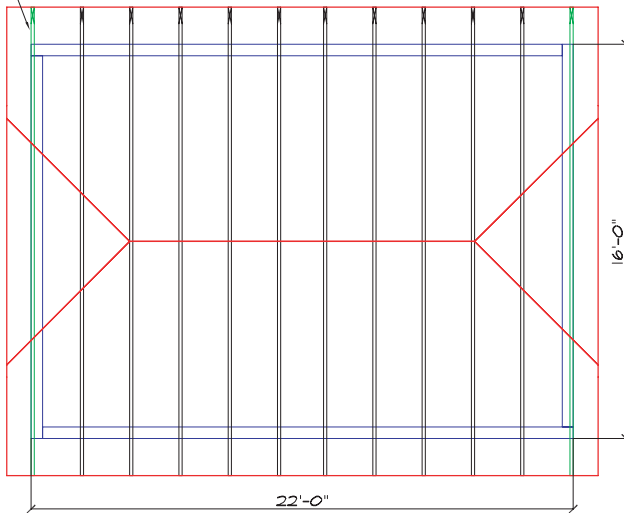

## Floor System

( \* See also – Floor Truss Systems )

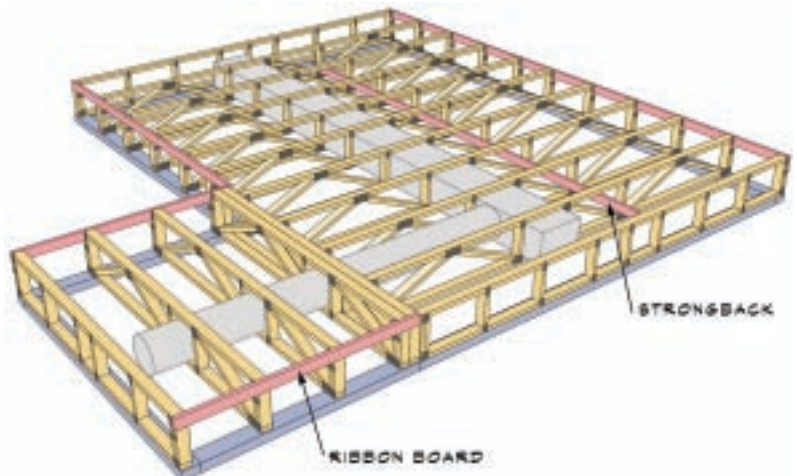
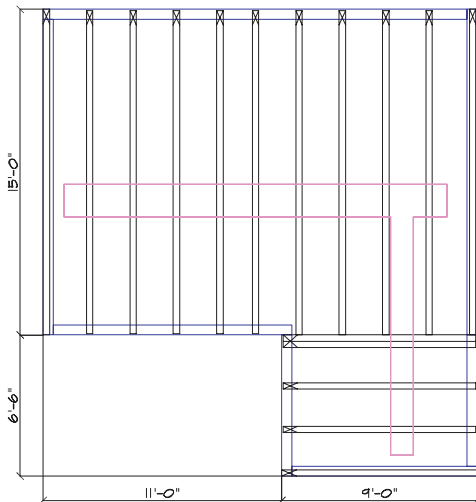

# Gable Framing Variations

## Dropped Gable

If the roof eave extends beyond the end wall enough to require support for the roof sheathing, then a dropped gable is specified. The top chord of the gable end is dropped down enough so that

- the builder can run outlookers from the fascia back
- to the first common truss. This provides enough
- additional support for the sheathing.
- 
- 

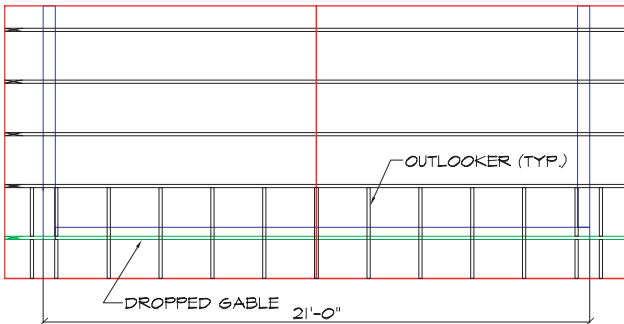

## Clear Span Gable

While most gable ends have continuous support under their bottom chords, a clear span gable must span from one wall to another. It has to have diagonal webs to help distribute the load out to the

- walls, but it also needs to have vertical gable studs
- to help the gable sheathing resist lateral wind
- forces.
- 
- 

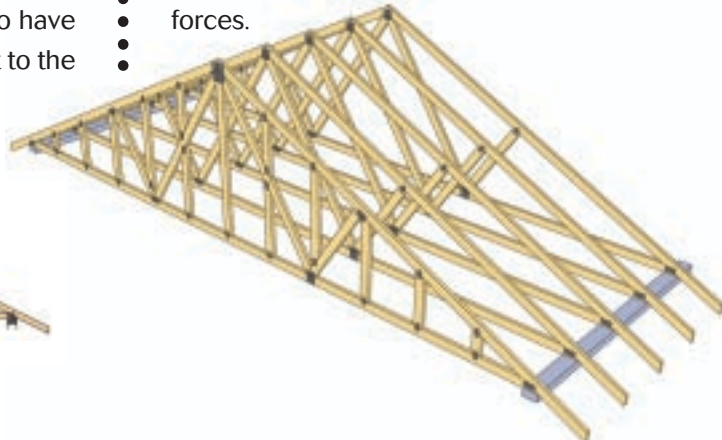

Alternative methods for framing a structural gable include the truss manufacturer providing a full gable truss (with just gable studs) and a full common truss, which would be fastened together with the gable end facing the wind, or providing studs along the outside face of a common truss.



## Transition Gable

A transition gable end truss occurs when a run of smaller span trusses leads up to parallel longer span trusses. The first longer span truss will face lateral wind loads in the area where it is not shielded by the smaller span trusses. In the

- smaller span area of that same gable, it doesn't
- have continuous support under its bottom chord.
- A transition gable, therefore, has diagonals to help
- transfer loads in the smaller span area, and gable
- studs in the part that faces the wind.

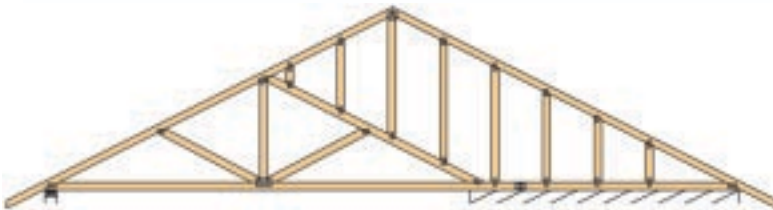
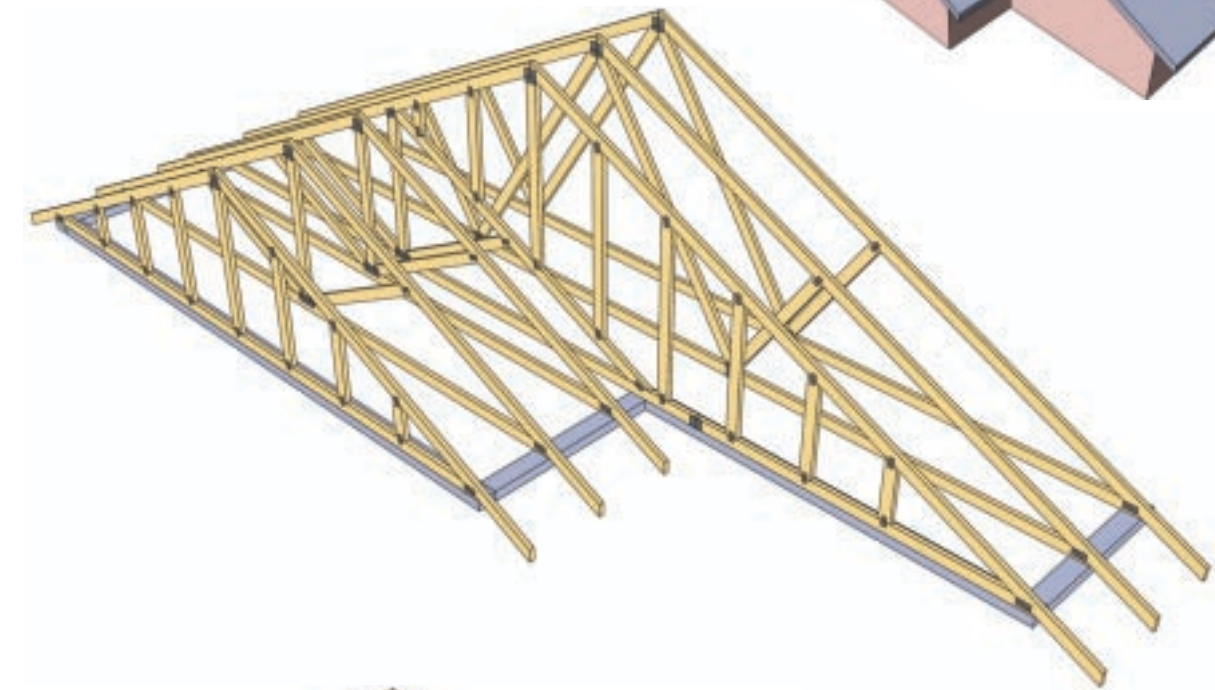
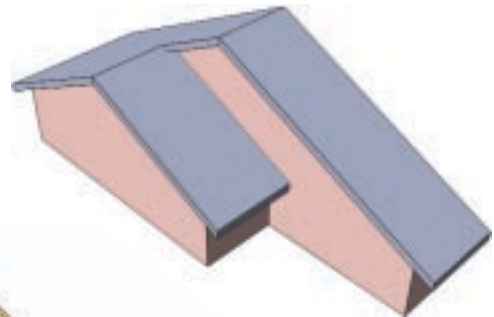
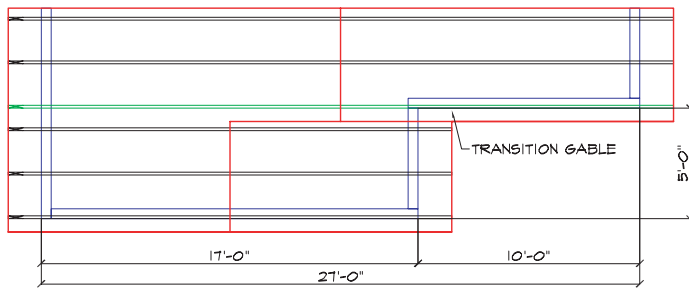



## Hip Set Framing Variations

Under the planes of a hip set roof, there are many different methods used to frame the trusses. Preferences for any given system hinges upon

- builder preferences, manufacturing efficiencies,
- cost, and ceiling requirements. Some of the most
- common hip systems are outlined below.

### Stepdown

A stepdown hip set provides a girder truss, with a hip jack running from the corners up the ridge until they meet the hip girder.

The builder must provide support for the hip ridge, usually in the form of blocking, or hip cats, in between each hip truss up to the peak.



### Midwest

The Midwest hip set also provides a girder truss, with hip trusses that step up to the peak.

However in a Midwest hip set, you run a rafter up from the corner of the front wall to the hip girder.

All the bottom chords of the end jacks run to the hip girder, allowing for better attachment of the drywall on the ceiling.

- Hip cats must be field cut and installed
- between the hip trusses if a dropped-in
- gable is not provided (for more info see
- Dropped-In Purlin Frame).

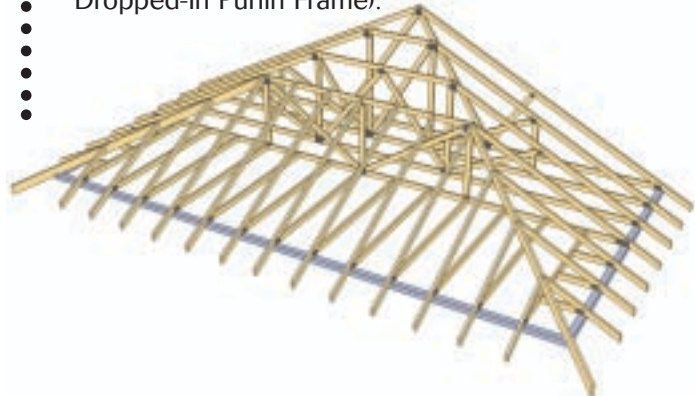

### California

Notice that a long rafter is provided for the length of the hip ridge so no cats or field support of the ridge is necessary.

All the bottom chords of the end jacks run to the hip girder, allowing for better attachment of the drywall on the ceiling, and the top chords of the end jacks run all the way up to the hip ridge. Proper support of extended top chords is critical.

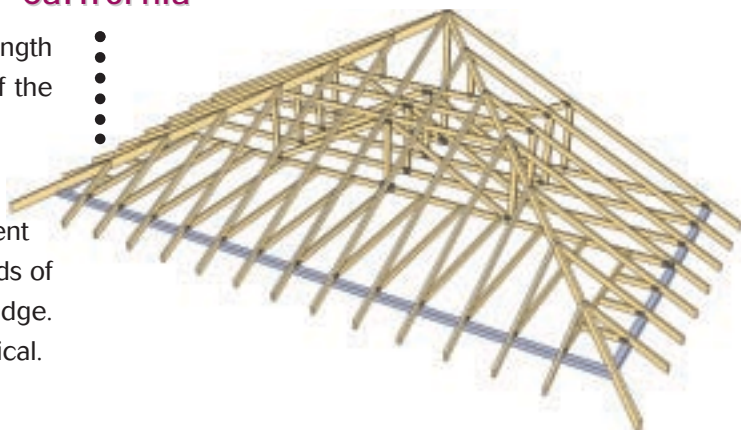

---

## Northeast

---

In a northeast hip set, you will find a short jack starting at the corner and running up the hip ridge. This hip jack stops at a sub-girder. All end jack bottom chords run to the hip girder, allowing for better attachment of the drywall on the ceiling. Hip cats must be field cut and installed between the hip trusses. Works well with dual-pitched hip systems.

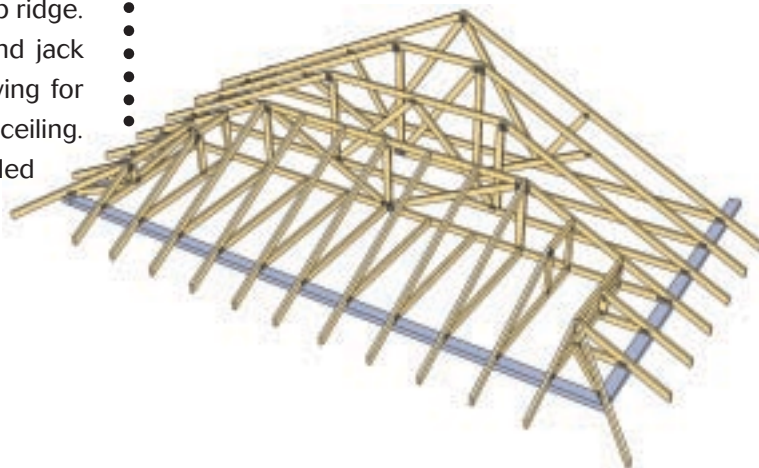

---

## Terminal

---

Terminal hip sets are used in spans up to about 30' to 32'. A ridge rafter runs from the corner up to the peak of the hip, and a sub-girder, located about half way to the peak, carries the side jack bottom chords while their top chords run up to the ridge rafter.



---

## Standard Terminal

---

The standard terminal hip set is used for very small spans, i.e. up to about 18' to 20'. The two hip jacks running up the corners and the center end jack all connect at the peak, which can make the peak connection difficult on longer spans.





---

## Drop-in Purlin Frame

---

An alternative method for providing support up the ridges of a hip set is for the truss manufacturer to drop the flat top chord of the hip trusses by 1 1/2", and provide a special purlin frame (in red) for the framing crew to drop in above the hip girder.

- The frame fits in the plane of the front face of the
- hip set, and provides additional rigidity to the roof
- system. Nailing sheathing into the 2x4 flat studs is
- also convenient.

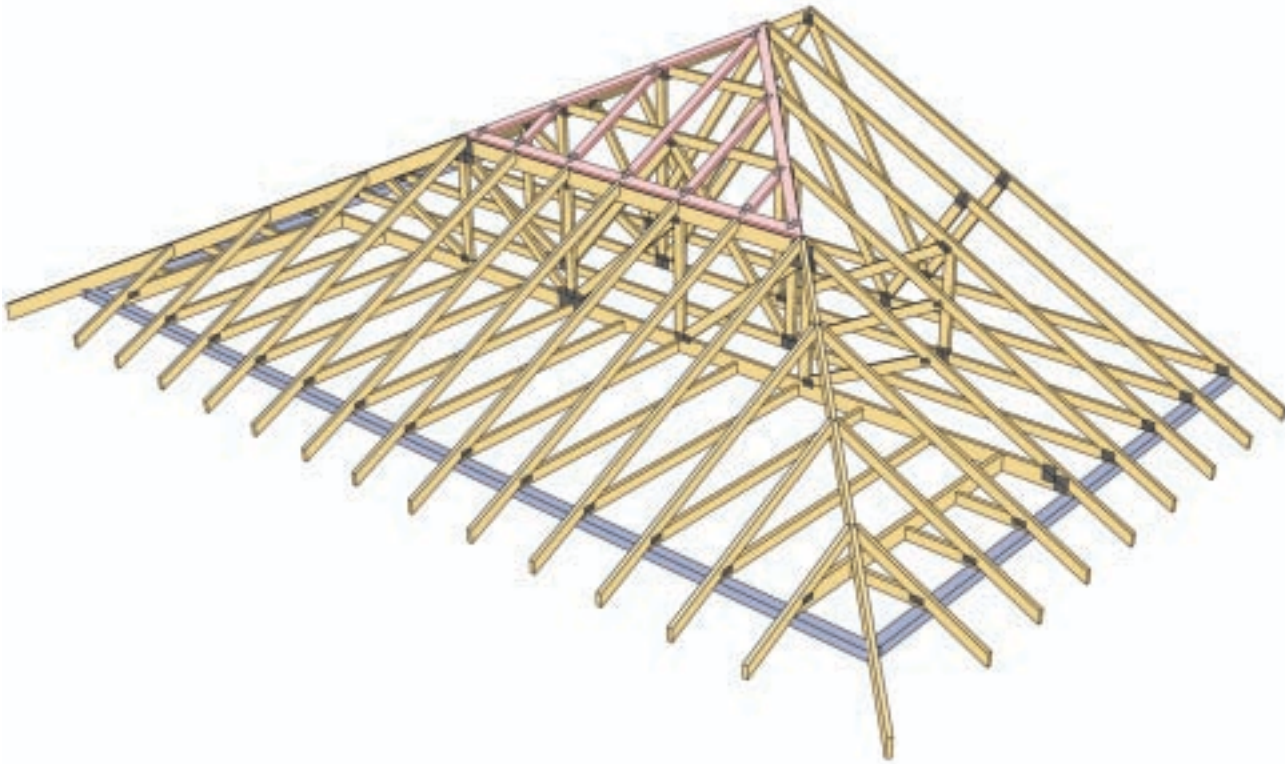

---

## Additional Truss Framing Options

---

Valley Set – A valley set is a group of trusses which sit on top of other trusses in order to change the way the roof looks. In the example below, without

- valleys, we would have an empty “hole” in the roof
- behind the girder. This would need either stick
- framing, or a valley set.

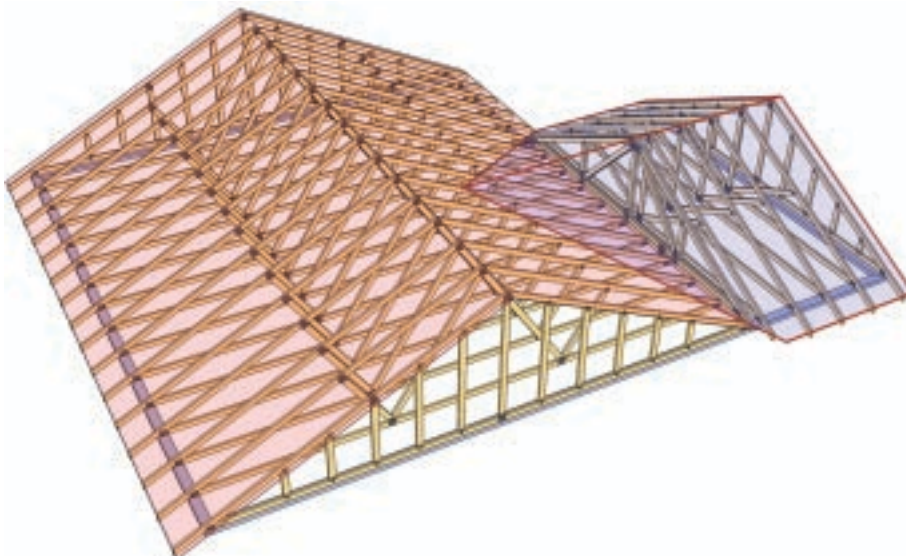

Here is what the roof looks like after the valley set (in red) is added.

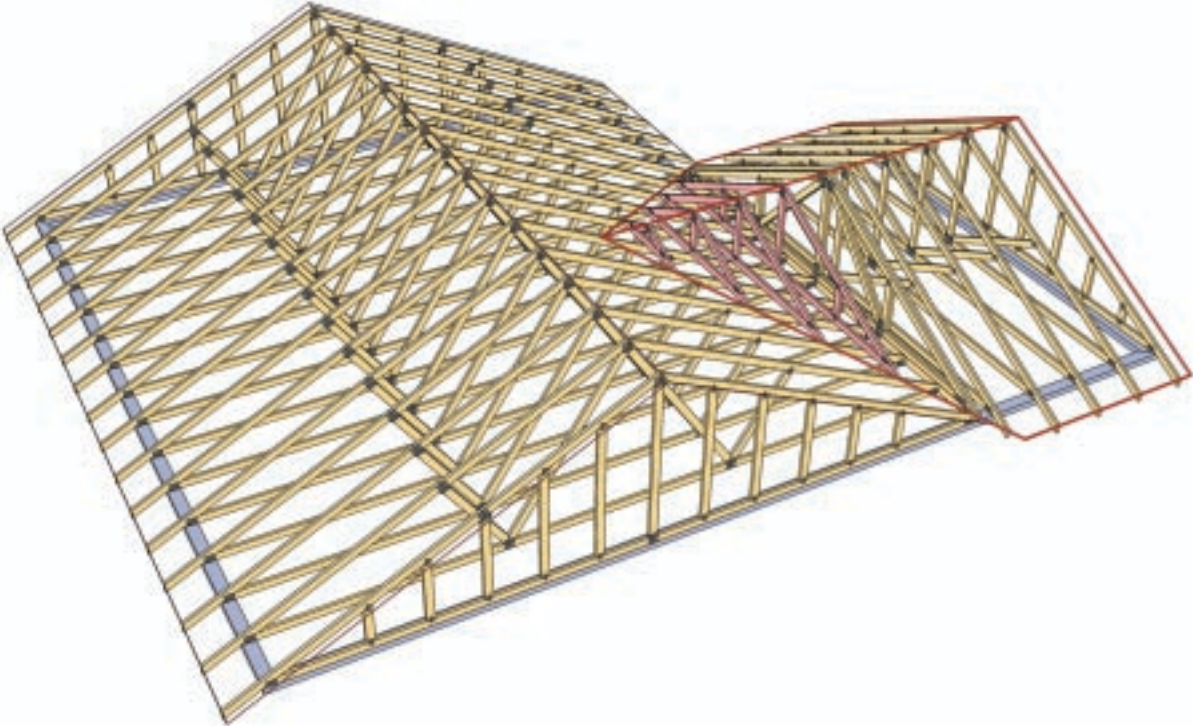

The top chords of the trusses which the valley set sits on must be braced, either by plywood under the valleys, or by alternate bracing.

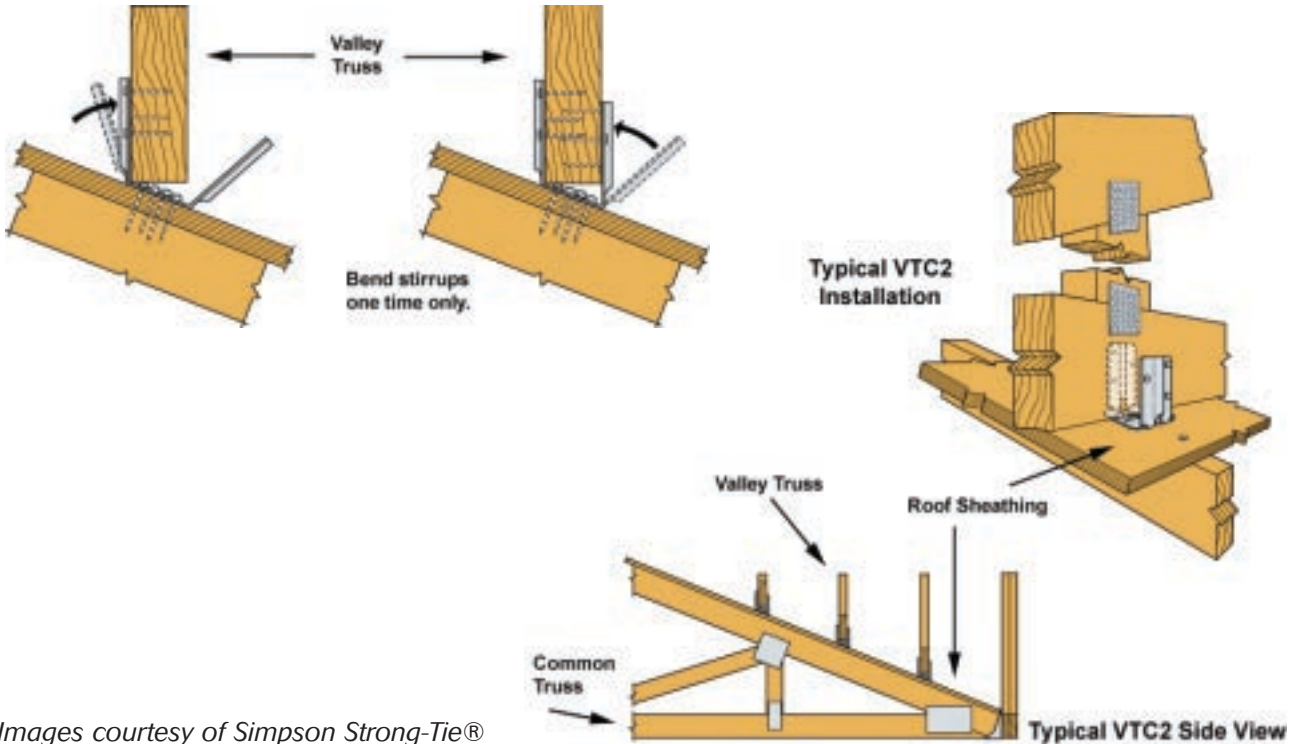

Images courtesy of Simpson Strong-Tie®



## Piggyback Trusses

When roof trusses are too tall to be manufactured and/or delivered, truss manufacturers will “cap” the trusses and provide piggy back trusses. The piggybacks below are shown above the roof so that the purlin and bracing system can be seen.

- Special diagonal bracing on the underside of the
- top chords (in red) helps brace the purlins
- themselves, and keeps them from shifting out of
- plane. Piggy back trusses can be designed using
- either vertical studs (as shown) or diagonal webs.

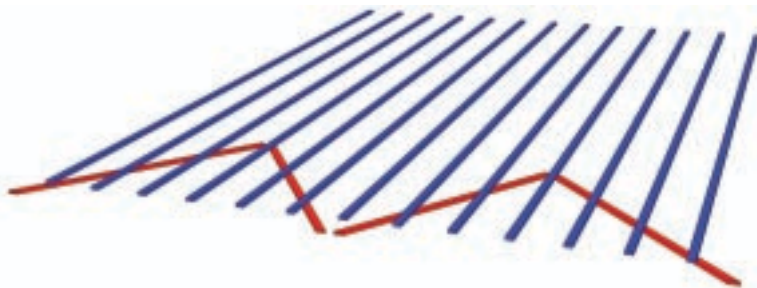
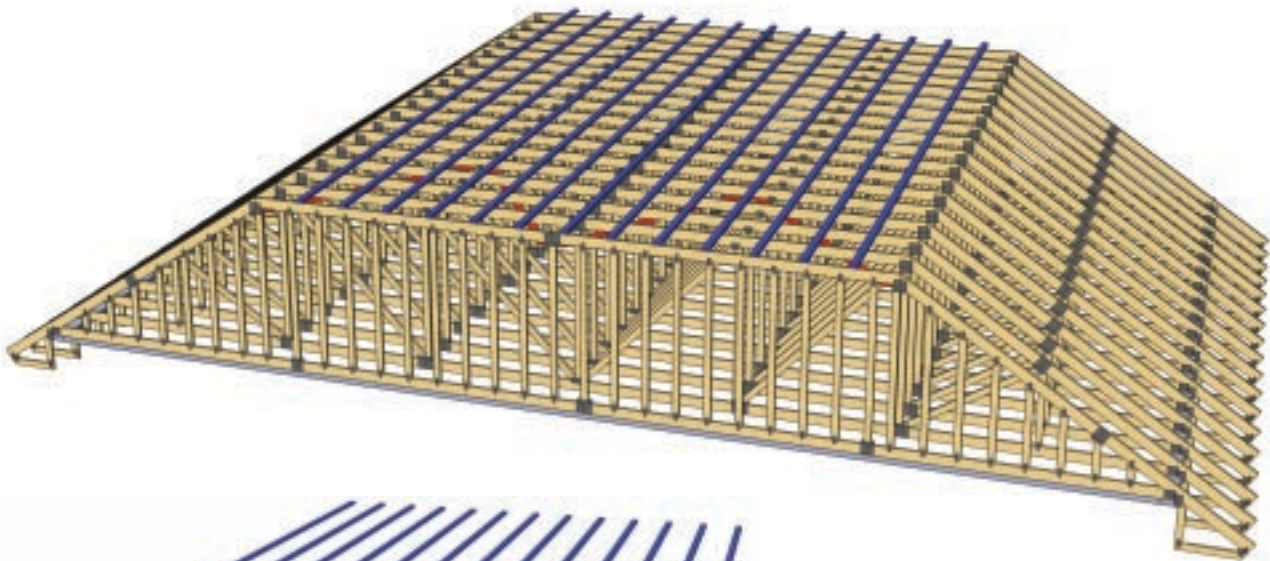

*Detail of the bracing system, with purlins (blue) and diagonal braces (red).*

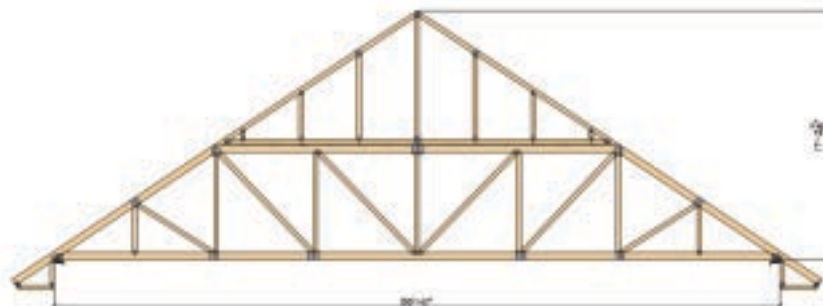

*Hip truss shown with piggyback (field applied)*

# Typical Truss Configurations



**King Post** -- Span Up to 16'



**Queen Post (Fan)** -- Spans 10' to 22'

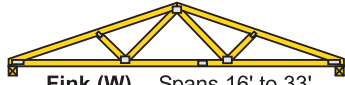

**Fink (W)** -- Spans 16' to 33'



**Howe (K)** -- Spans 24' to 36'

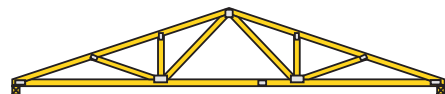

**Fan (Double Fan)** -- Spans 30' to 36'

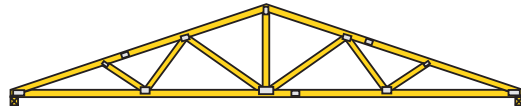

**Modified Queen (Multi-Panel)** -- Spans 32' to 44'

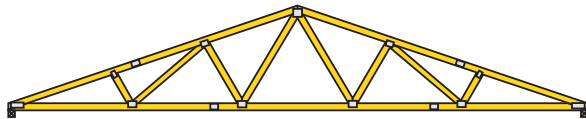

**Double Fink (WW)** -- Spans 40' to 60'

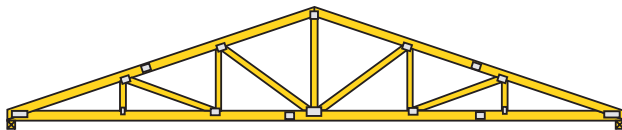

**Double Howe (KK)** -- Spans 40' to 60'

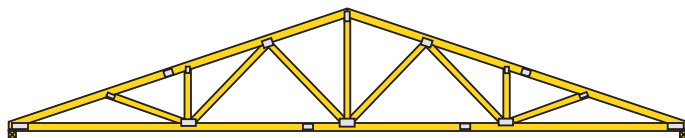

**Modified Fan (Triple Fan)** -- Spans 44' to 60'

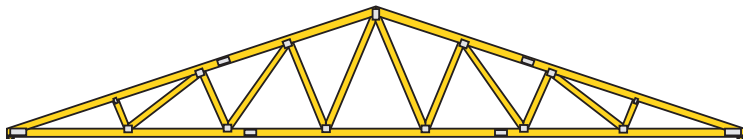

**Triple Fink (WWW)** -- Spans 54' to 80'

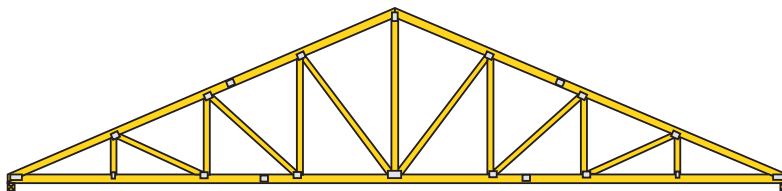

**Triple Howe (KKK)** -- Spans 54' to 80'

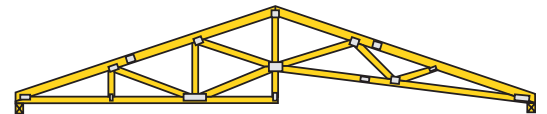

**Vault - Two Bearing Points**

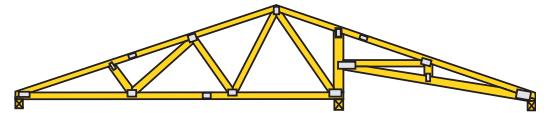

**Vault - Three Bearing Points**

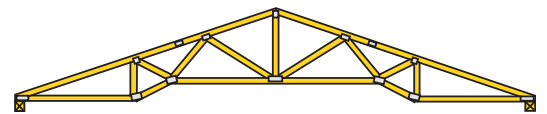

**Coffer (Cove)**

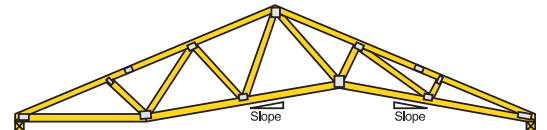

**Cathedral (CATH)**

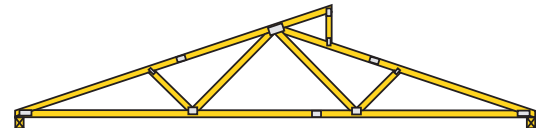

**Clear Story**

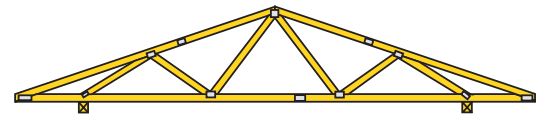

**Double Cantilever**

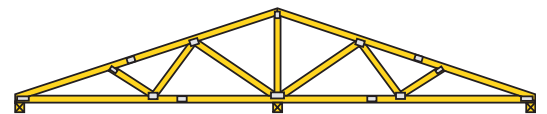

**Tri-Bearing**

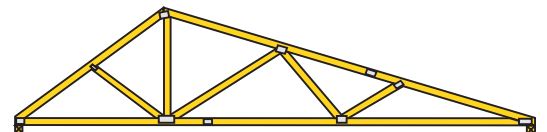

**Double (DUBL)  
(Double Pitch)**

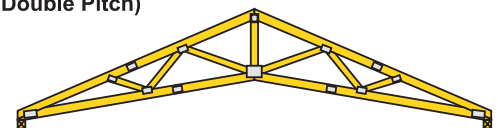

**Modified Queen  
Scissors**

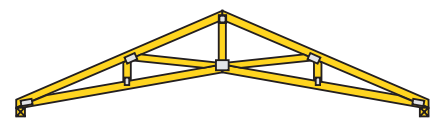

**Howe Scissors**

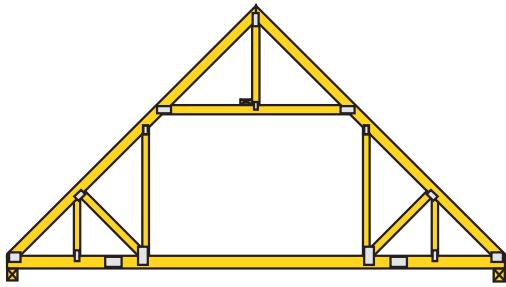

Room-In-Attic

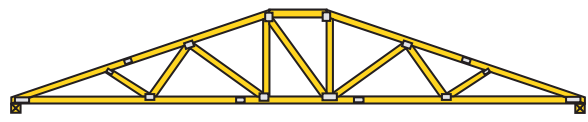

Steppedown Hip

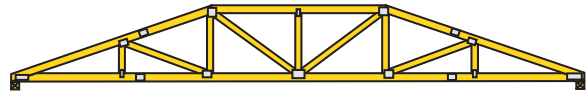

Hip Girder

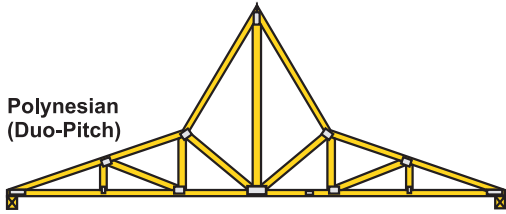

Polynesian (Duo-Pitch)

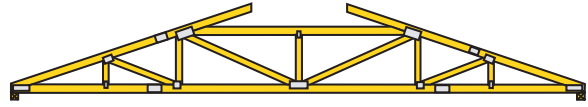

California Hip

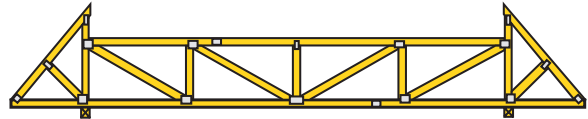

Double Cantilever With Parapets

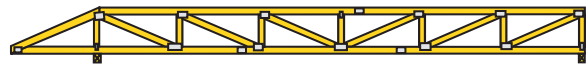

Flat Truss With Cantilever (Pratt Configuration)

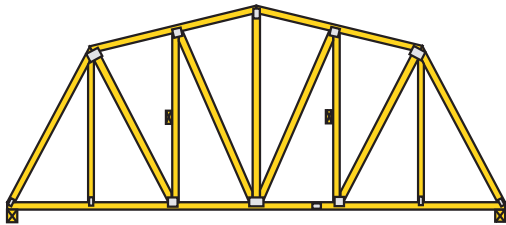

Gambrel



Top Chord Bearing Flat Truss (Pratt Configuration)

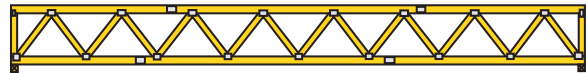

Flat Truss (Warren Configuration)

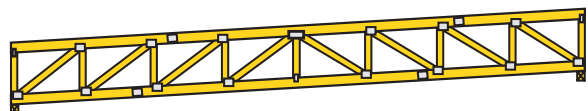

Sloping Parallel Chords (Howe Configuration)

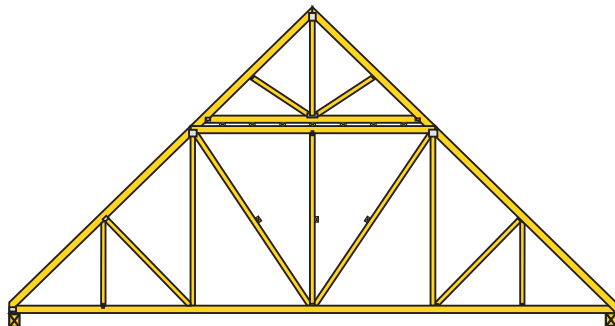

Piggyback

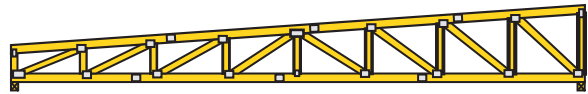

Sloping Top Chord (Howe Configuration)



Floor Truss (System 42 - Modified Warren Configuration)

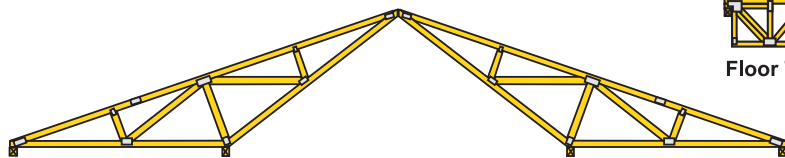

Double Inverted -- Lengths 50' to 80'

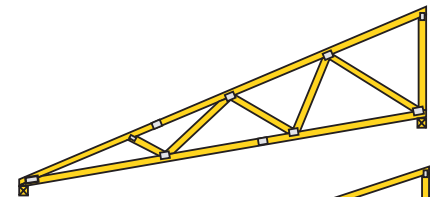

Scissors Mono

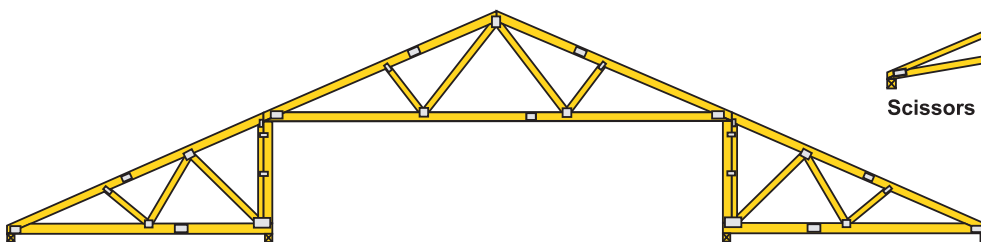

Three Piece Raised Center Bay -- Lengths 50' to 100'+

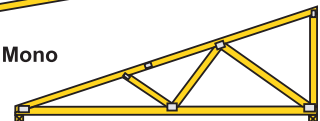

Mono



## Typical Truss Shapes

The outside profile of your truss can take on just about any shape you can imagine. Some of the more common truss shapes appear below.



COMMON



HIP

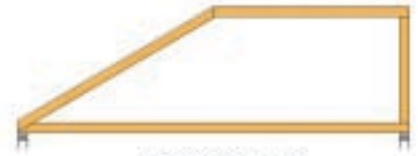

MONO HIP

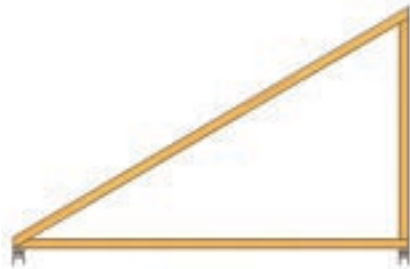

MONO



MONO SCISSORS



SLOPING FLAT



SCISSORS



HIP SCISSORS



VAULT



GAMBREL



DOUBLE PITCH



FLAT



PITCHED FLAT

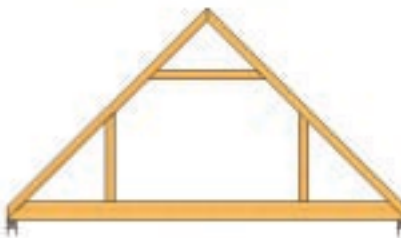

ATTIC



PORCH



CAMBER



POLYNESIAN HIP



SY42 FLOOR



# Typical Bearing / Heel Conditions

Exterior bearing conditions - The illustrations below show typical support conditions.

- "Typical" Bottom Chord end condition

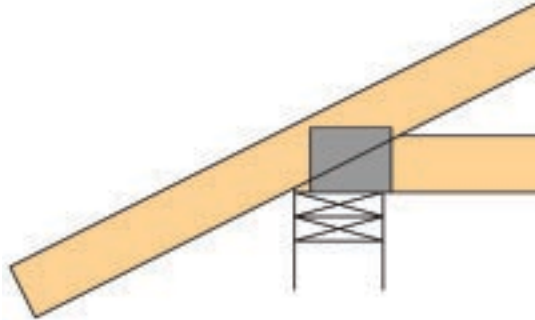

Typical conditions include a girder heel (one where the top chord stops when it meets the bottom chord), a truss heel without an overhang, and/or with a raised heel, and/or with a sloped ceiling, for example:

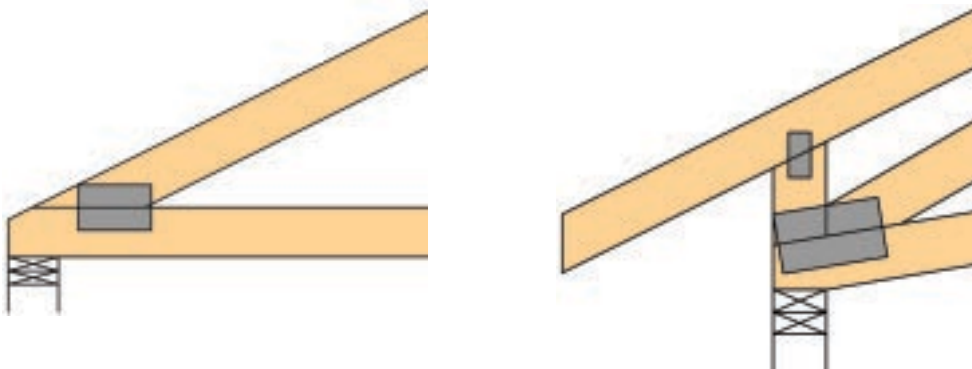

Bearing support types for each can be any of the following:

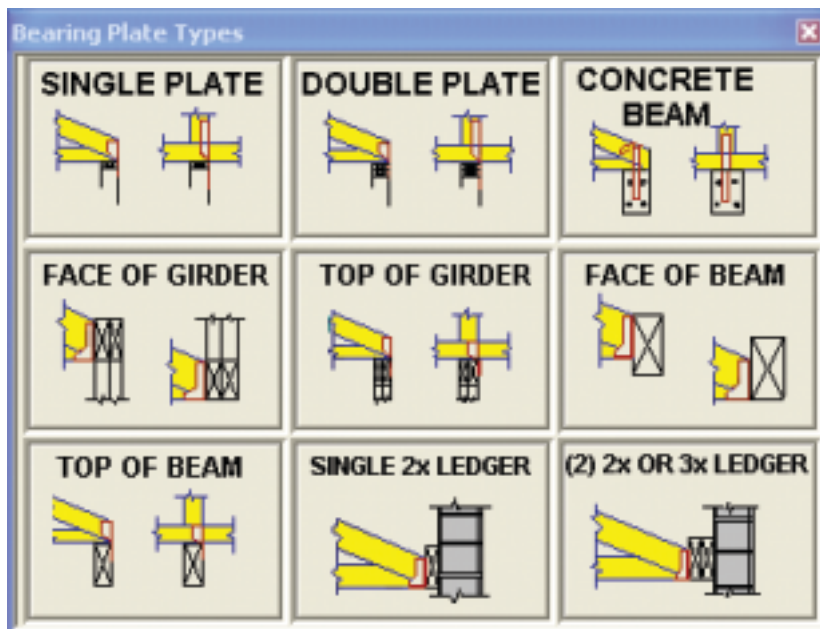
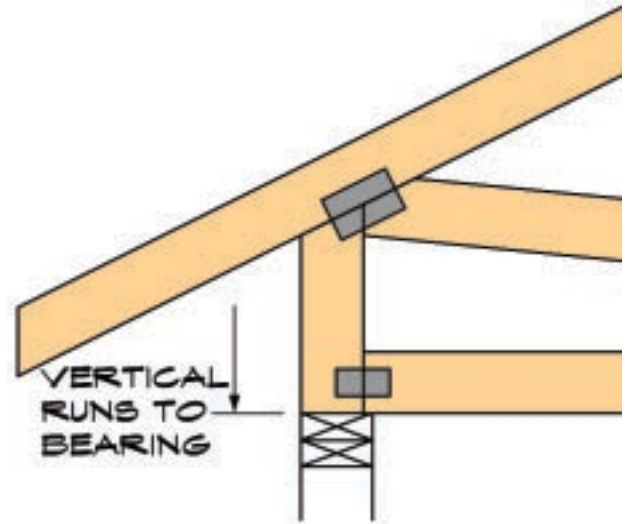
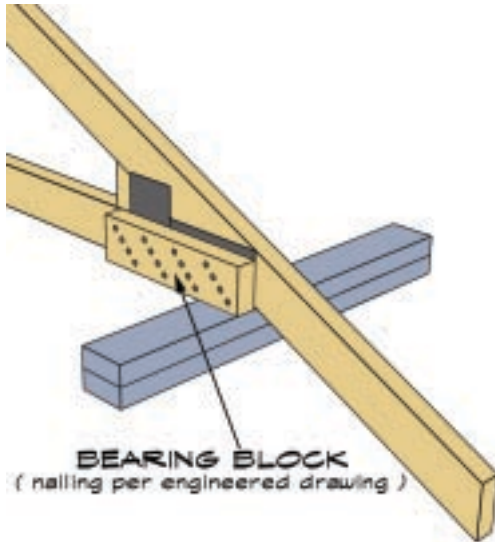

Image from Alpine's VIEW® software

Additional conditions and options include:

- **Crushing at the heel** - Sometimes the forces transferred through the wood into the bearing wall are enough to cause the wood to crush over time, unless either a bearing block is used, or, on a raised heel condition, the end vertical is run through to the bearing wall (so the wood

- grain is running up and down, which has a higher shear value), or unless the bearing itself is made wider so the forces are transferred through more surface contact area between the truss heel and the bearing.



- **Trusses sitting on concrete walls** - When the truss sits on a concrete wall, a seat plate may be required as a moisture barrier:

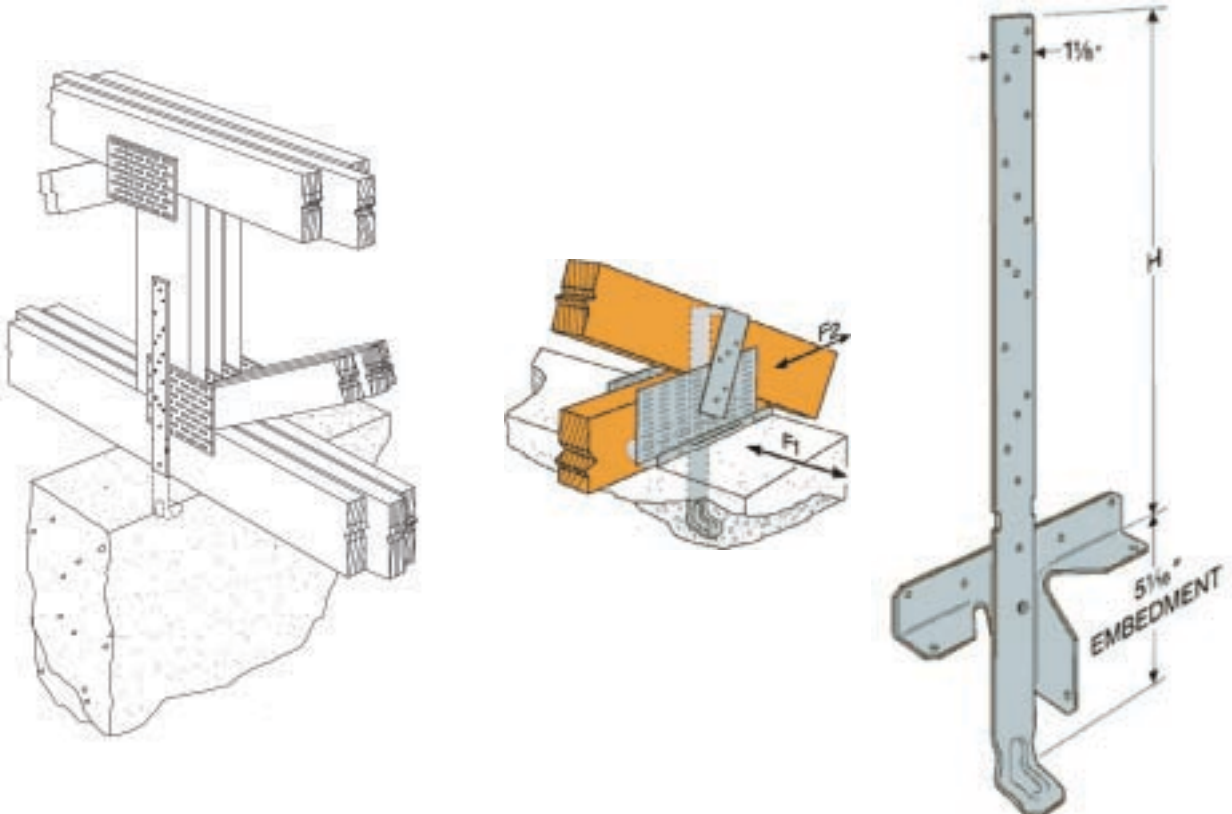

Images courtesy of Simpson Strong-Tie®

Other Bottom Chord Bearing conditions:

Truss in a hanger:

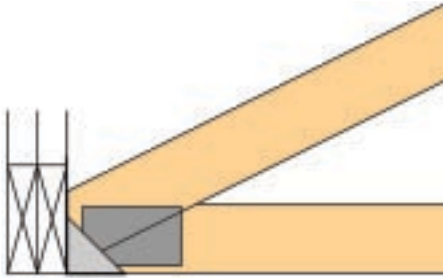

Truss nailed to a girder/ledger (Right end):

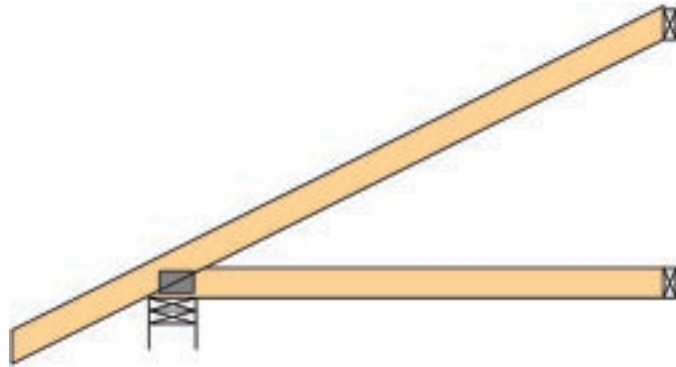

- **Top Chord bearing** – Trusses can be designed to have support right under the top chord. You will want to shim the bearing solid under the top chord of the truss.

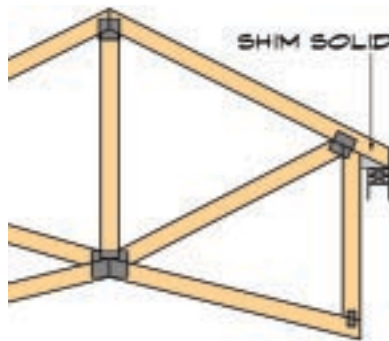

- **Mid-Height bearing** – Sometimes the bearing sits between the top and bottom chord of the truss, and a mid-height bearing block (the 2x6 vertical shown here) will be used.

- **Leg-Thru to the bearing** – If the bearing is below the truss bottom chord, the end vertical of the truss can extend down to sit on the bearing. Special bracing may be required.

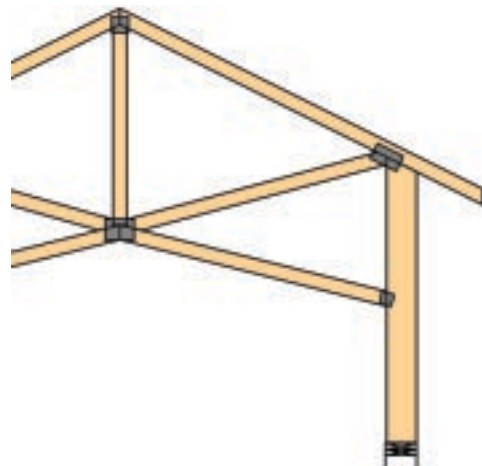
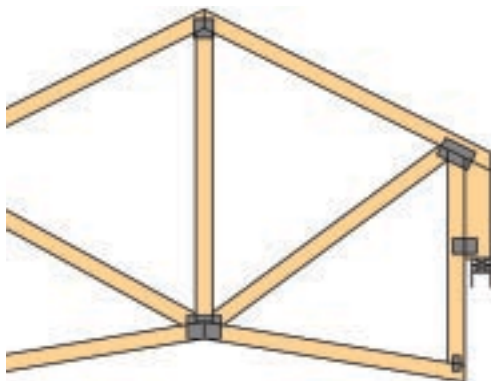



- **Tail bearing tray** – If the room calls for a tray or coffered ceiling very close to the edge of the room, the truss can look like these tail bearing tray trusses below. The example on the right

- calls for a scab to be attached (an additional piece of wood nailed to the face, or both faces, of the top chord at the heel, as shown by the hatched pattern).

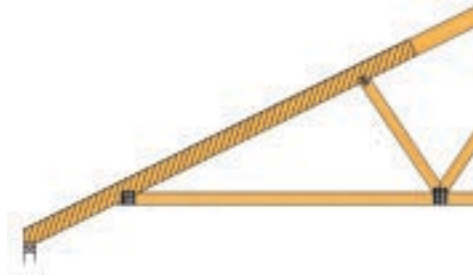
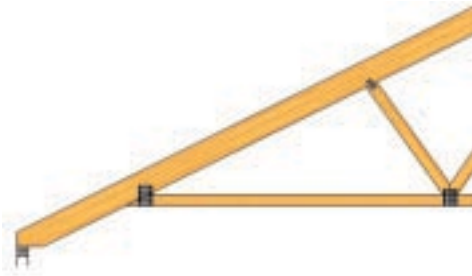

**Interior bearing conditions**



*Two trusses sharing a wall*



*Interior bearing*



*Built-in kneewall (see 3D image)*



**Special Connection Notes:**

- It is important to properly tie down the truss to your bearing walls, and not just in areas prone to hurricanes. There are many products that are

- designed for this purpose. These products should not only anchor the truss into the wall, but also tie the truss down to resist both uplift and lateral forces.

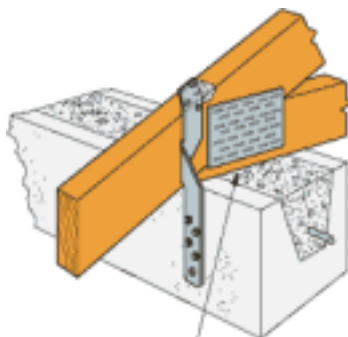

*Moisture barrier not shown*

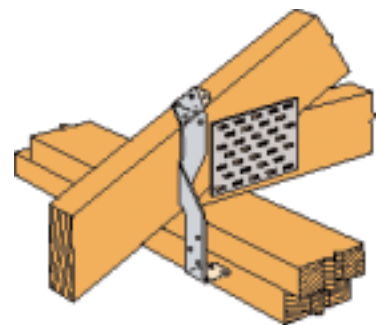
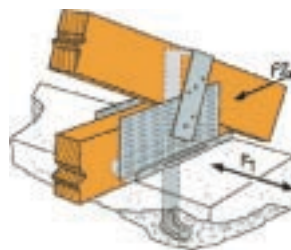

*Images courtesy of Simpson Strong-Tie®*

## Typical Heel Conditions

- The top chord that extends beyond the bottom chord and bearing is called an overhang.



The outside cut of your overhang can look like any of the images below.

**Plumb Cut**

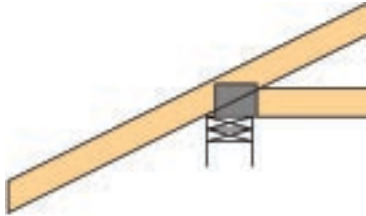

**Square Cut**

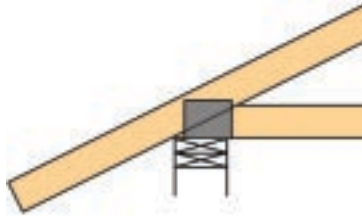

**Double Cut**

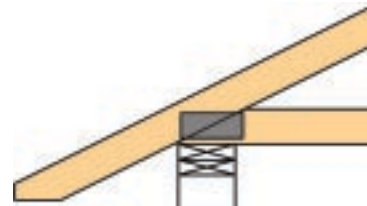

**Special Angle Cut**

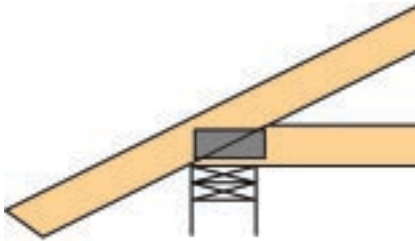

**Horizontal Cut**

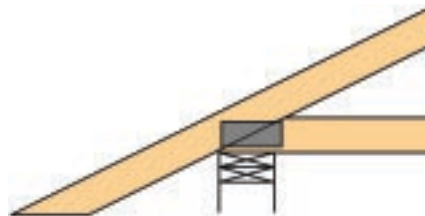

**Optional End Cosmetics** – In addition, the truss overhang can have optional cosmetic framing applied.

- Level Return:** A level return is a horizontal member creating a soffit under the overhang. The level return on the left side builds up the fascia to 5 1/2", and uses a vertical to stiffen it. The level return on the right side creates a box soffit, and is plated to the raised heel of the truss.

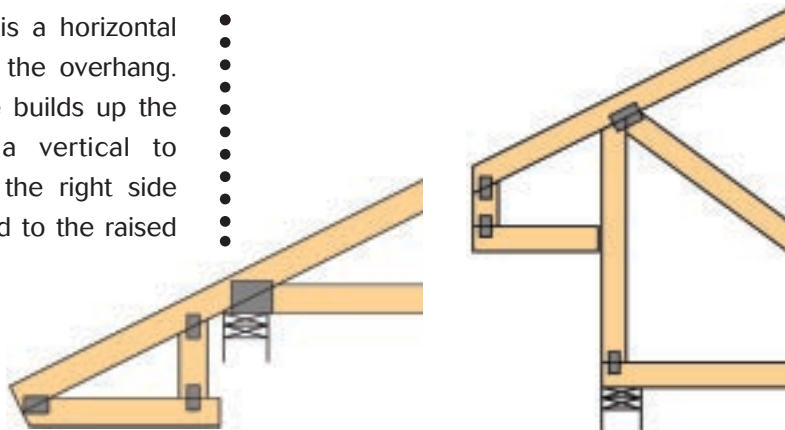

- Nailer:** If some trusses on the job have a 2x6 top chord, and some have a 2x4 top chord, you can keep a consistent fascia edge by applying a ripped piece of lumber to the under side of the overhang. This piece is called a nailer.

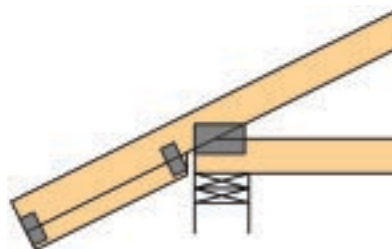

- **Parapet:** On trusses with raised heels, you can build in a parapet condition to your truss. This parapet can be used to either hide A/C units (on a flat truss, when the A/C unit is located on top of the flat roof), or to hang signage. Additional bracing may be required for parapet conditions, especially in high wind areas.

Flat roof trusses should always have a slope running from the center of the truss to the outside. This prevents water from accumulating on the roof, and is especially important with parapets. Adequate scuppers must be provided to ensure proper drainage.

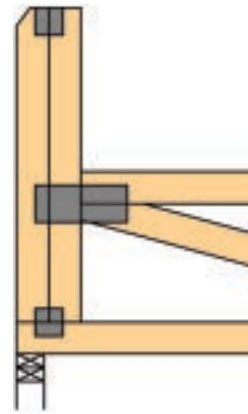

- **Mansard ends:** For storefront signs or just for another look, special mansard jack trusses can be manufactured.

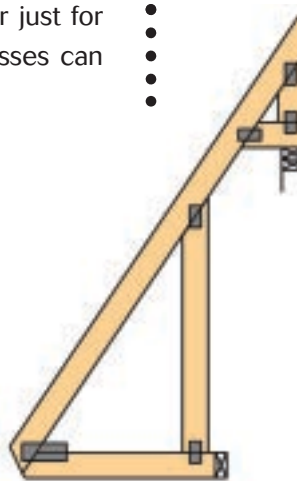

- **Cantilevers and Stubs** – Two common conditions for trusses are **cantilevers** (when the truss bottom chord extends beyond the outside

- wall) and **stubs** (when there is a jog in the wall or some other reason why the truss would be held back from its original span).

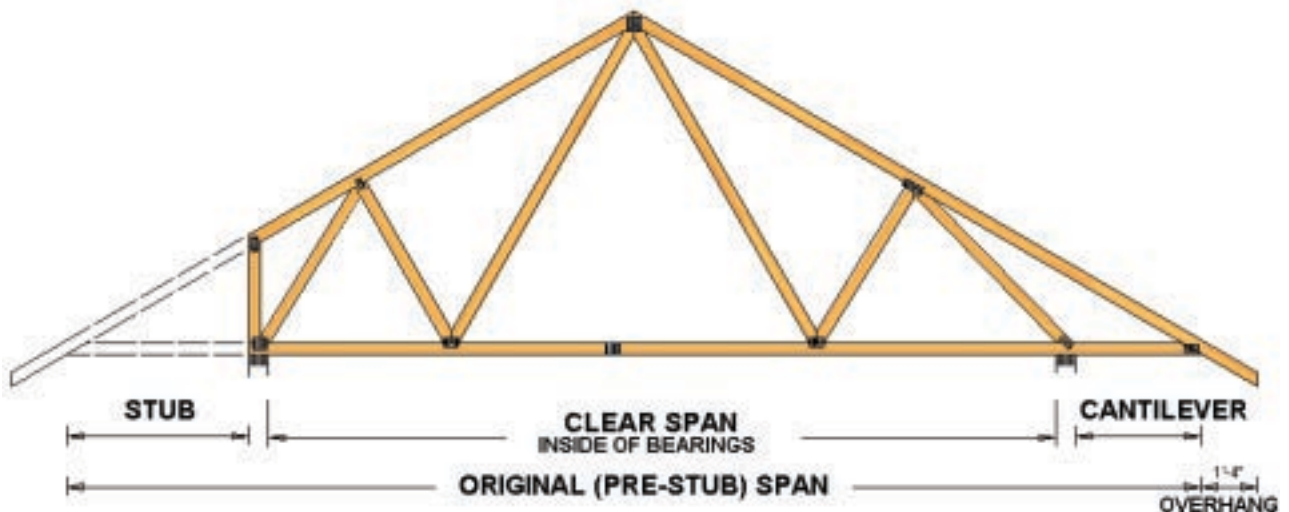



# Bracing Examples

## Web Bracing

**CLB:** Continuous lateral bracing (CLB) is 1x4 or 2x4 material nailed to the narrow side of a web.

CLB braces must be fastened across a minimum of 3 trusses. If you don't have a run of at least 3 trusses, you must use another type of brace.

- The CLB brace here is shown in blue, with diagonal bracing to "brace the brace" shown in red.
- The truss drawing will show a brace on the web, and will also have a note specifying the brace, as shown to the left here.

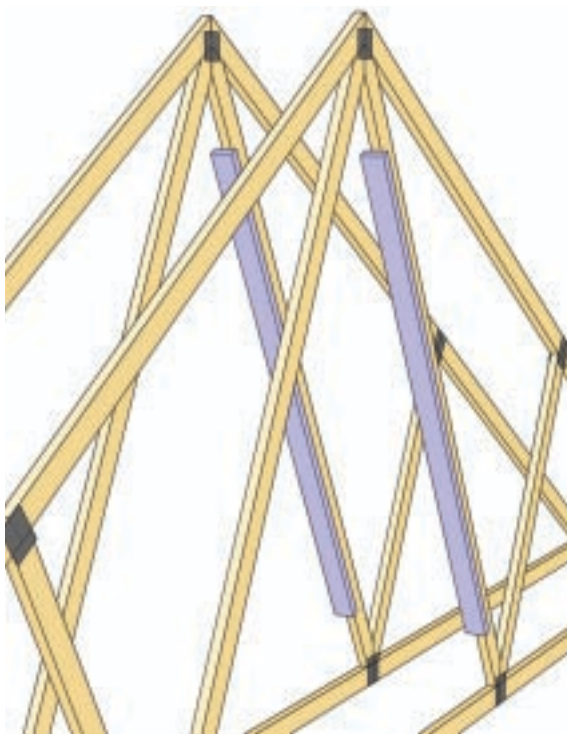
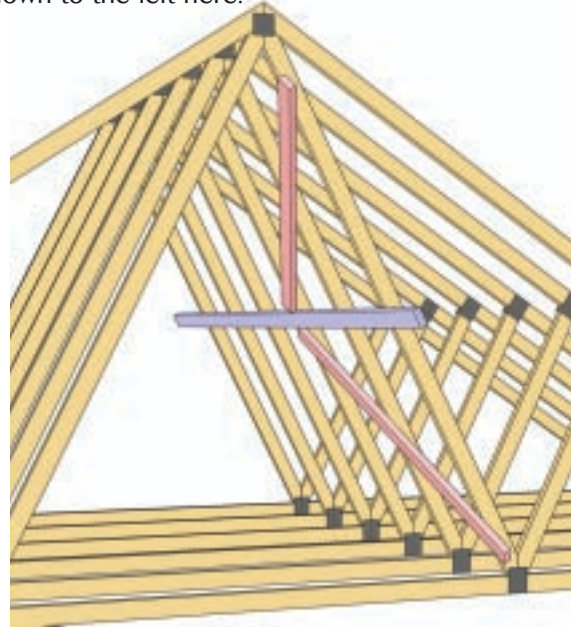
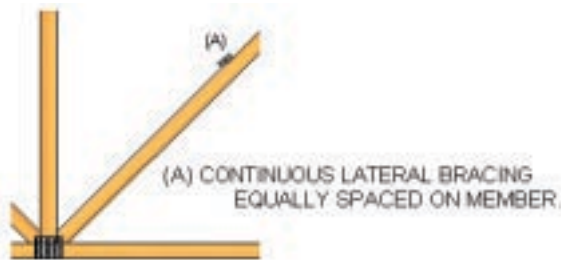

- **T-Brace:** A T-Brace is 1x or 2x material fastened to the narrow face of an individual web so as to form a "T" shape.

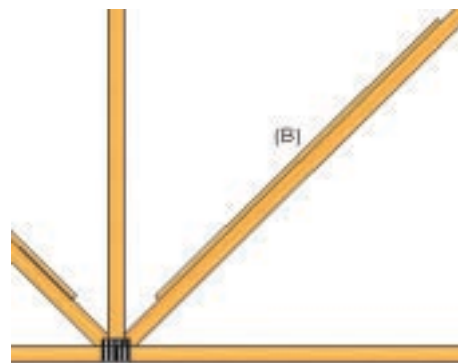

(At right) Truss drawing depicting a T-Brace, and bracing note (below)

(B) 1x4 #3 OR BETTER "T" BRACE. 80% LENGTH OF WEB MEMBER. ATTACH WITH 8d NAILS @ 6" OC.

(A) 2x6 #3 OR BETTER "T" BRACE. 80% LENGTH OF WEB MEMBER. ATTACH WITH 16d NAILS @ 6" OC.

**L-Brace** - L-Braces are pieces of 1x or 2x lumber attached to individual webs to form an "L" shape. These braces are usually specified for gable ends, when one face of the truss will be sheathed.

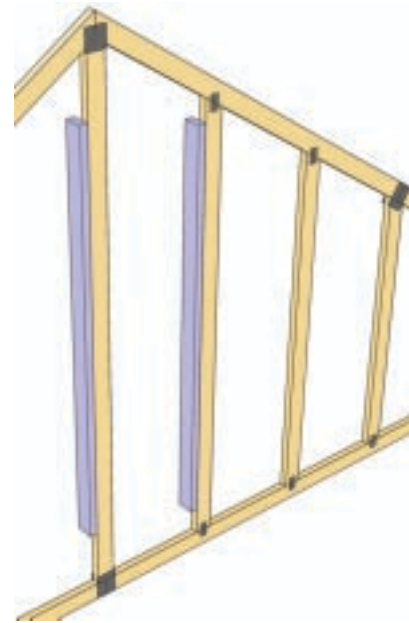

L-Brace note from a truss drawing (below)

(A) 1x4 #3 OR BETTER "L" BRACE. 80% LENGTH OF WEB MEMBER. ATTACH WITH 8d NAILS @ 6" OC.

**Scab Brace** – A scab brace is applied to the wide face of the web member, using the same size lumber as the web itself.

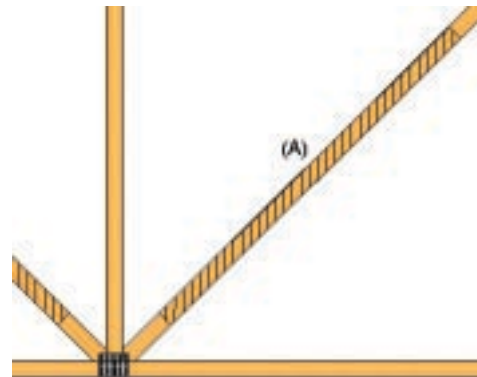

(A) #3 OR BETTER SCAB BRACE. SAME SIZE & 80% LENGTH OF WEB MEMBER. ATTACH WITH 10d NAILS @ 6" OC.

**Web Block®** & Other methods for reducing field applied bracing – If you are open to reducing the amount of time your framers are in the roof system applying web bracing, and you don't mind paying just a little bit extra for the truss package, the software used by truss fabricators allows them to use manufactured solutions like the Web Block (shown, at right), or to increase web grades and sizes to considerably reduce the need for field applied bracing. Talk with your local truss manufacturer about these alternatives!

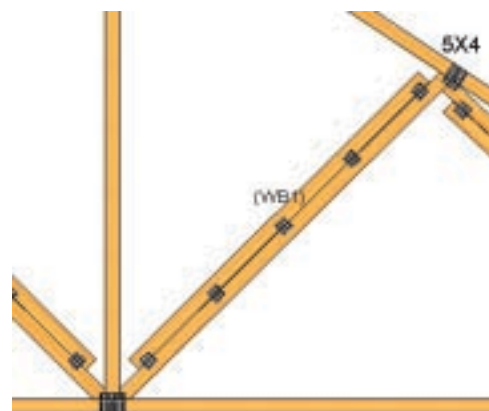

## Erection of Trusses

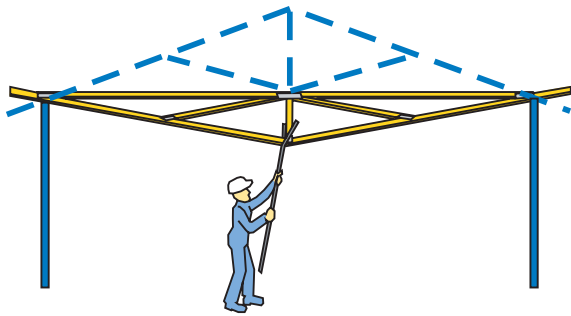

Manual Installation

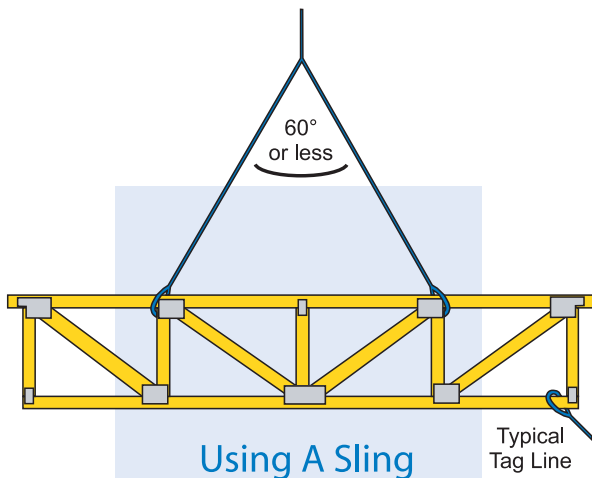

Using A Sling

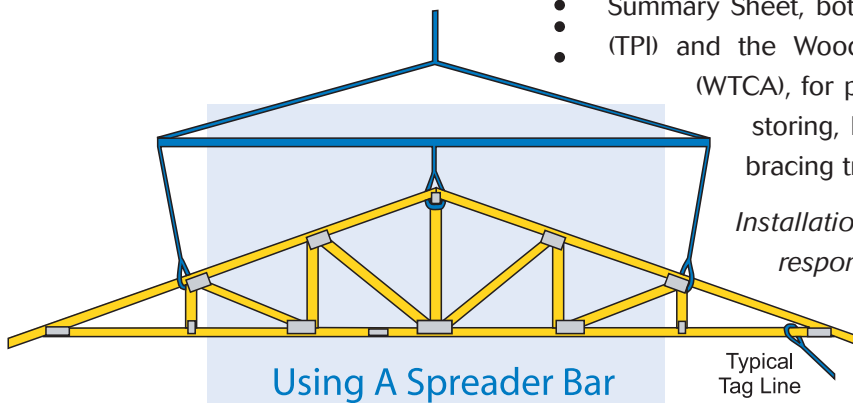

Using A Spreader Bar

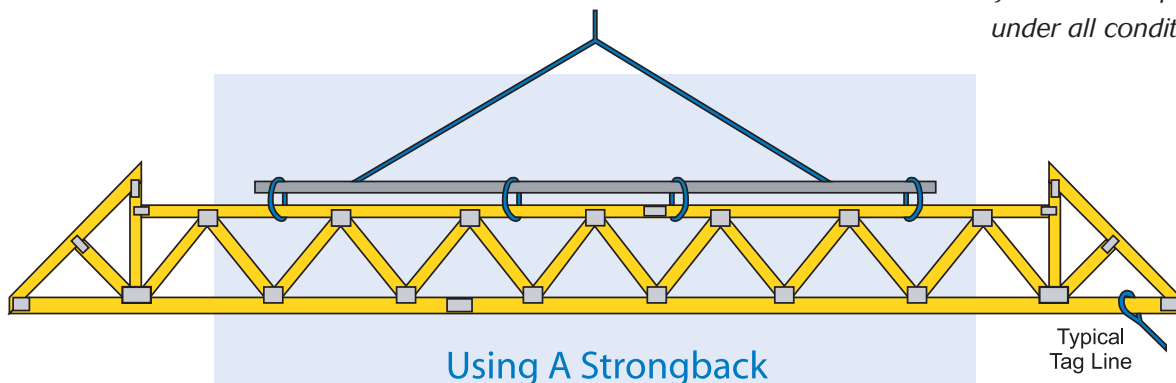

Using A Strongback

Trusses may be installed manually, by crane, or by forklift, depending on truss size, wall height and job conditions. Individual trusses should always be carried vertically to avoid lateral strain and damage to joints and members.

Trusses installed manually are slid into position over the sidewall and rotated into place using poles. The longer the span, the more workers needed to avoid excessive lateral strain on the trusses. Trusses should be supported at joints and the peak while being raised.

Large trusses should be installed by a crane or forklift employing chokers, slings, spreader bars and strongbacks to prevent lateral bending. Trusses may be lifted singly, in banded groups, or preassembled in groups.

Tag lines should always be used to control movement of trusses during lifting and placement.

Refer to the Building Component Safety Information BCSI 1-03 Booklet and/or the BCSI-B1 Summary Sheet, both by the Truss Plate Institute (TPI) and the Wood Truss Council of America (WTCA), for proper methods of unloading, storing, lifting, erecting, installing and bracing trusses.

*Installation procedures are the responsibility of the installer. Job conditions and procedures vary considerably. These are only guidelines and may not be proper under all conditions.*



## Temporary Bracing

All trusses must be securely braced, both during erection and after permanent installation. Individual trusses are designed only as structural components. Responsibility for proper bracing always lies with the building designer and contractor for they are familiar with local and job-site conditions and overall building design. All trusses should be installed straight, plumb and aligned at the specified spacing. Trusses should also be inspected for structural damage.

There are two types of bracing. Temporary bracing is used during erection to hold the trusses until permanent bracing, sheathing and ceilings are in place. Permanent bracing makes the truss component an integral part of the roof and building structure. Temporary and permanent bracing includes diagonal bracing, cross bracing and lateral bracing.

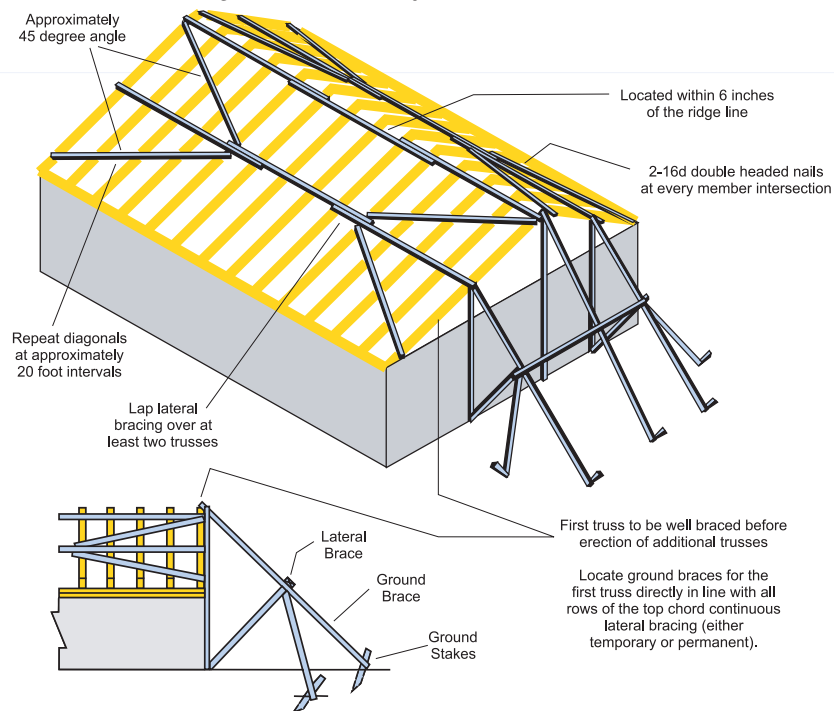

Permanent lateral bracing, as may be required by truss design to reduce the buckling length of individual truss members, is part of the truss design and is the only bracing specified on the design drawing. This bracing must be sufficiently anchored or restrained by diagonal bracing to prevent its movement. Most truss designs assume continuous top and bottom chord lateral support from sheathing and ceilings. Extra lateral and diagonal bracing is required if this is not the case.

Bracing members are typically 2x4s nailed with two 16d nails at each cross member unless otherwise specified on the design drawing. Cross and diagonal braces should run on an approximate 45 degree angle.

It is important to temporarily brace the first truss at the end of the building. One method calls for the top chord to be braced by ground braces that are secured by stakes driven in the ground, preferably outside and inside. The bottom chord is to be securely anchored to the end wall. Additional trusses are now set and connected together with continuous rows of lateral bracing on the top chord. These are typically spaced at 4', 6', 8', or 10 feet on centers along the length of the truss. Refer to BCSI 1-03 for diagonal spacing. This top chord bracing will be removed as the sheathing is applied after the other bracing is completed, unless specifically designed to be left in place.

Temporary bracing should be 2x4 dimension lumber or larger and should be 8 feet minimum in length. Continuous lateral bracing maintains spacing, but without cross bracing, permits trusses to move laterally. See BCSI 1-03.

To prevent dominoing, diagonal bracing should be installed in the plane of the webs as the trusses are installed. See BCSI 1-03.

Full bundles of sheathing should not be placed on the trusses. They should be limited to 8 sheets to a pair of trusses. Likewise, other heavy concentrated loads should be evenly distributed.

- Inadequate bracing is the reason for most truss installation failures. Proper installation is a vital step for a safe and quality roof structure.

- These recommendations are offered only as a guide. Refer to Recommended Design Specifications for Temporary Bracing of Metal Plate Connected Wood Trusses (DSB-89) by the Truss Plate Institute (TPI), or Building Component Safety Information BCSI 1-03 Booklet by TPI and WTCA.
- For cold formed steel truss systems, refer to LGSEA's two publications, Field Installation Guide for CFS Trusses, and Design Guide for Construction Bracing of CFS Trusses.

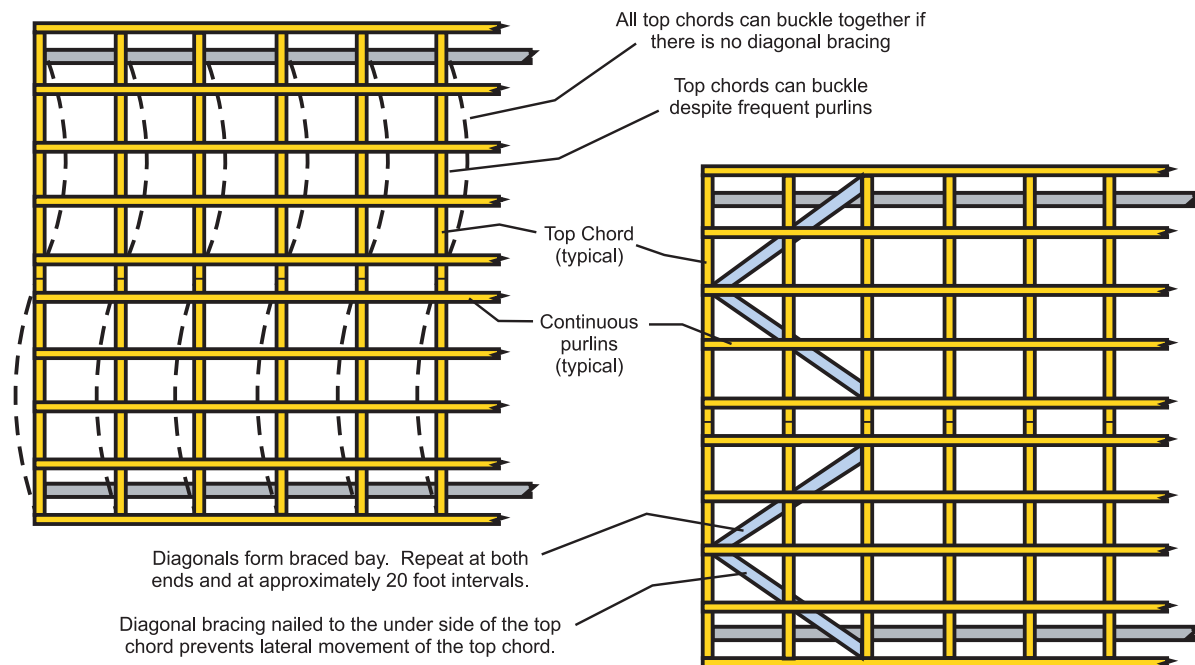
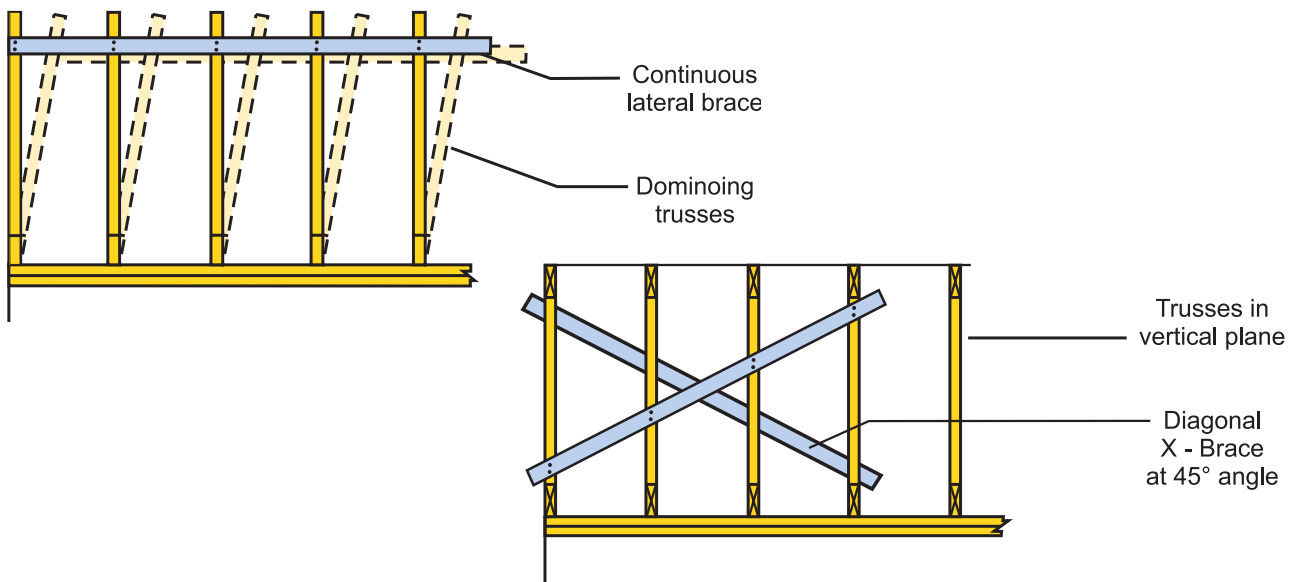

# CHECKLIST FOR TRUSS BRACING

**Bracing is extremely IMPORTANT!!** Every roof system needs adequate bracing. The purpose of most bracing is to ensure that the trusses and truss members remain straight and do not bow out of their plane. Inadequate, improper or incorrectly installed bracing can lead to collapses, failures and serious accidents. An engineered bracing system will avoid these pitfalls and ensure the structural integrity of the truss system.

Trusses need to be braced during installation, which is called **Temporary Bracing**, and they need

• **Permanent Bracing** which will remain installed for the life of the roof system.

• **Temporary Bracing Guidelines:** For metal plate connected wood truss systems, refer to **BCSI 1-03** for proper installation bracing guidelines. For cold formed steel truss systems, refer to LGSEA's two publications, [Field Installation Guide for CFS Trusses](#), and [Design Guide for Construction Bracing of CFS Trusses](#).

## Permanent Bracing System Checklist

### 1. Top Chord Planes

- Do top chord planes have structural sheathing (plywood, OSB, metal deck)?
- If not, do you have a purlin system, with both purlins (perpendicular to the trusses) and diagonal bracing? Purlin systems can be used for standing seam roofs, or with structural sheathing applied on top of the purlins. Either way, a diagonal brace system must be engineered. Refer to sealed engineered truss designs for specified purlin spacing.

### 2. Web Bracing – be sure to reference sealed engineered truss designs for proper web bracing callouts.

- CLB Bracing crosses a minimum of 3 trusses, including diagonal bracing to “brace the bracing”?
- Properly installed T-Braces, L-Braces (especially on gable ends), Scab Braces, and other web bracing systems such as the Web Block?

### 3. Bottom Chord Planes

- Do bottom chord planes have structural sheathing directly attached? In many cases drywall is considered by the building designer to be lateral bracing, but in some cases it is not.
- If not, then you will need a purlin system, which can be attached to the top of your bottom chords, and those purlins will need diagonal braces.
- If you have any suspended ceilings, do you have a purlin system (including diagonal bracing) on the top or bottom of those bottom chords?

### 4. Additional Bracing Concerns

- Piggyback Systems* – If you have piggyback systems, do you have a purlin system installed to support the bottom chord of the piggyback, as well as purlins and diagonal braces to ensure that the flat top chords of the hip trusses stay in plane?
- Valley Sets* – Under the valley trusses, do you have structural sheathing, or other engineered bracing system for the top chords of the trusses underneath? Are the valley bottom chords adequately fastened down?
- High Heel Heights at a Wall* – for trusses with heel heights greater than a nominal 2x6, is special heel blocking required and installed?
- Blocking For the Ridge in Hip Systems* – Have you added blocks on the ridge between each hip truss (where a rafter or extended hip jack top chord doesn't extend to the peak of the hip system) to support the decking?



# Floor Systems

Another popular application for truss systems is in floor systems. Floor systems can be trussed, conventionally framed, or built with engineered wood products such as I-Joists. Both trusses and engineered wood products are engineered, and have wider nailing surfaces for the floor decking. Trusses are built with open chases for ductwork and have natural open spaces for plumbing and electrical wiring. Some engineered wood products have specified or marked notches that can be removed to allow for the same.

Floor truss systems are sometimes called System 42's, because to build them manufacturers turn the 2x4's on their side. This allows for shallow

depths as well as a 3 1/2" nailing surface. Some floors are built from 3x2's, others from 2x4's.

Floor trusses can be manufactured with many different possible end conditions to accommodate different installation needs; around raised walls, pocketed beams, headers around stairways, etc. In addition, some manufacturers are taking advantage of adding an I-Joist to the end of a truss to make it a trim-able end. Then the truss can be manufactured just a bit long, and easily trimmed back as needed in the field. Two of the most common web patterns for floor trusses appear below:

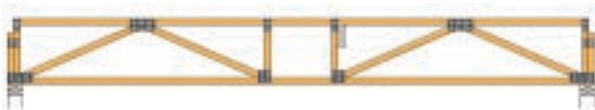

Fan configuration web style



Warren configuration web style

Is it OK to move a floor truss? Typical floor trusses are engineered to be spaced evenly, and the truss design drawing will tell you how far apart the trusses are designed to be. Occasionally the need will arise to shift one of the floor trusses from

where it was designed to be. When this happens, please contact the truss manufacturer to be sure it works. Sliding a floor truss even a few inches puts more load on the truss you're moving it away from, as shown in the drawing below.

**Check with the truss manufacturer before shifting a truss !**

IF YOU SHIFT IT:	THEN THE OVERSTRESSED TRUSS CARRIES:	B
24" on center trusses	3" 6.2% more load than it was designed for	27"
	6" 12.5% "	30"
	9" 18.7% "	33"
16" on center trusses	3" 9.3% more load than it was designed for	19"
	6" 18.7% "	22"
	9" 28.1% "	25"

# Typical Bearing / Heel Conditions for Floor Trusses

## Exterior bearing conditions

- **Bottom chord bearing** – trusses can sit on a wall, or in a floor truss hanger.

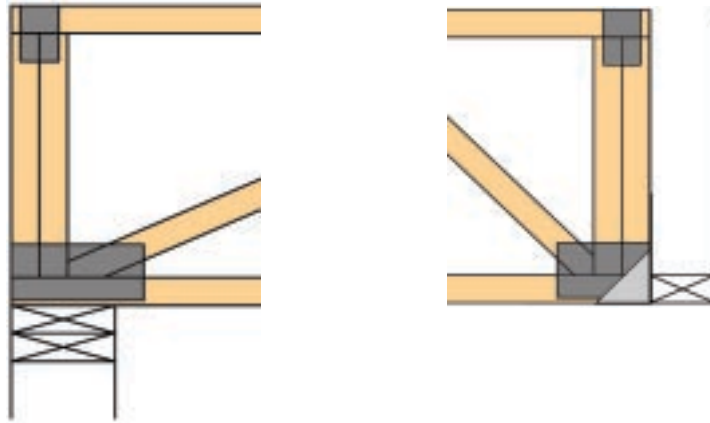

- **Top Chord bearing** – When the bearing is raised under the top chord, the end can be built with or without an end vertical, and with or without an additional slider for extra strength.

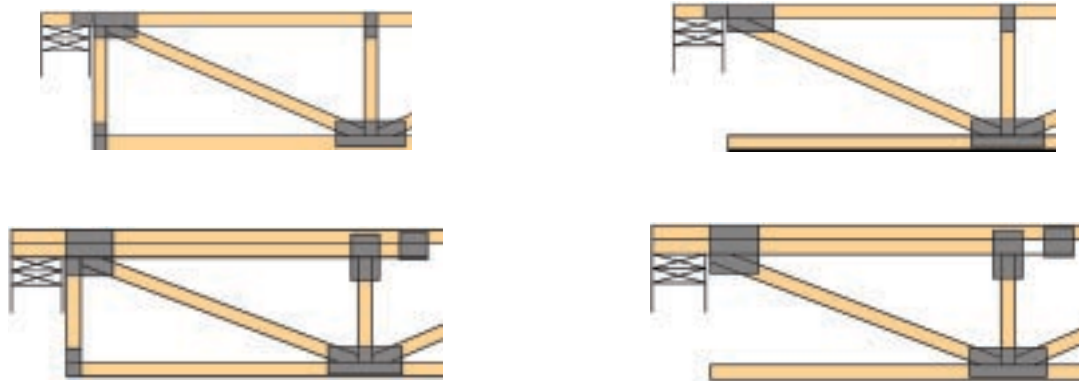

- **Mid-Height bearing** – When the bearing is raised between the top chord height and the bottom chord elevation, the end will use either a solid 4x block of wood, or multiple 4x2 verticals at the heel. It can also be built with or without an end vertical, and with or without an additional slider for extra strength.

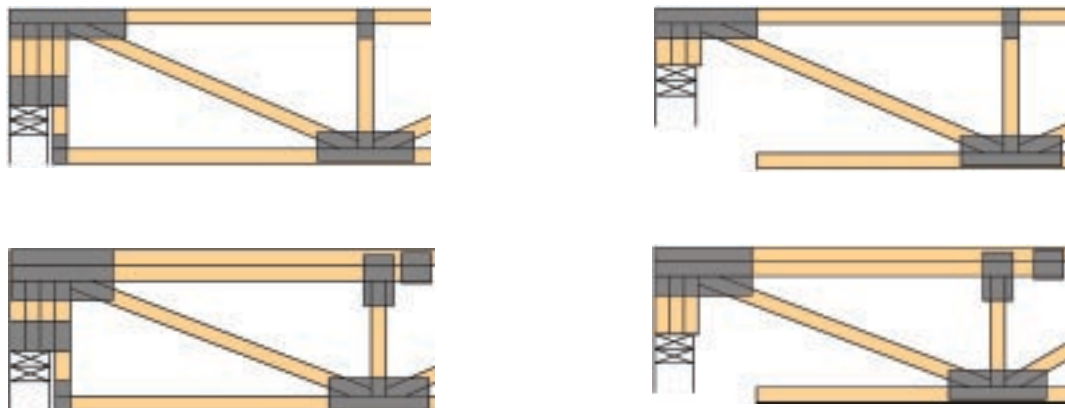

## Interior bearing conditions

- This truss is supported by an interior load bearing wall.

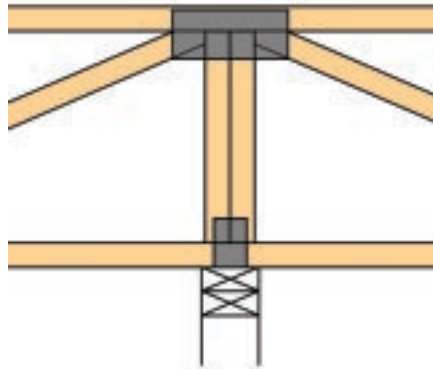

- **Cut chord condition** – Over an interior load bearing wall, a truss can also be built with a cut chord condition. This truss is designed to be cut into two separate trusses in the field.

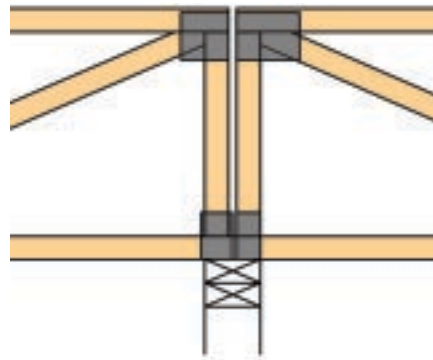

- **Beam Pocket** – This truss has a “pocket” built into it so the support can be recessed up into the truss.

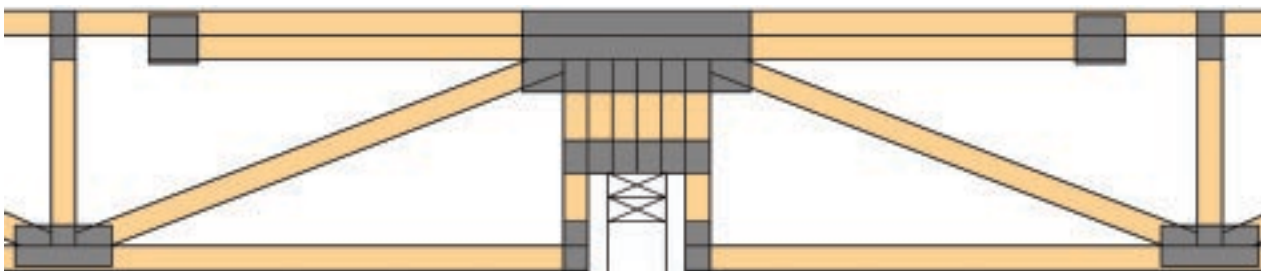

- **Threaded Beam** – This truss has an opening designed to bear on a beam, which will be designed and then threaded into the truss to help support it.

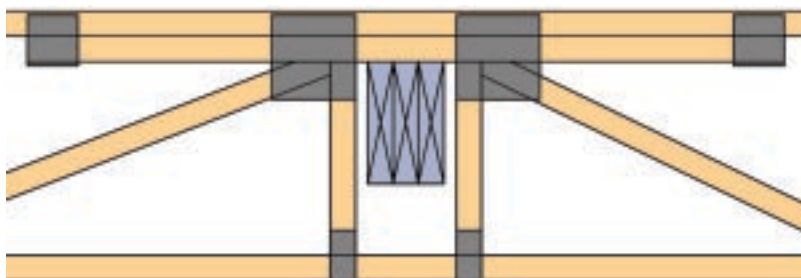



## Ribbon Boards, Strongbacks and Fire Cut Ends

- **Ribbon Notches** – Floor truss ends can have a notch built into the top of the truss end, the bottom of the truss end, or both. The purpose of these notches is to help the framer line up the trusses. By putting a 2x4 board at the end of the first few trusses, the remaining trusses can easily be slid into place when they hit the ribbon board.

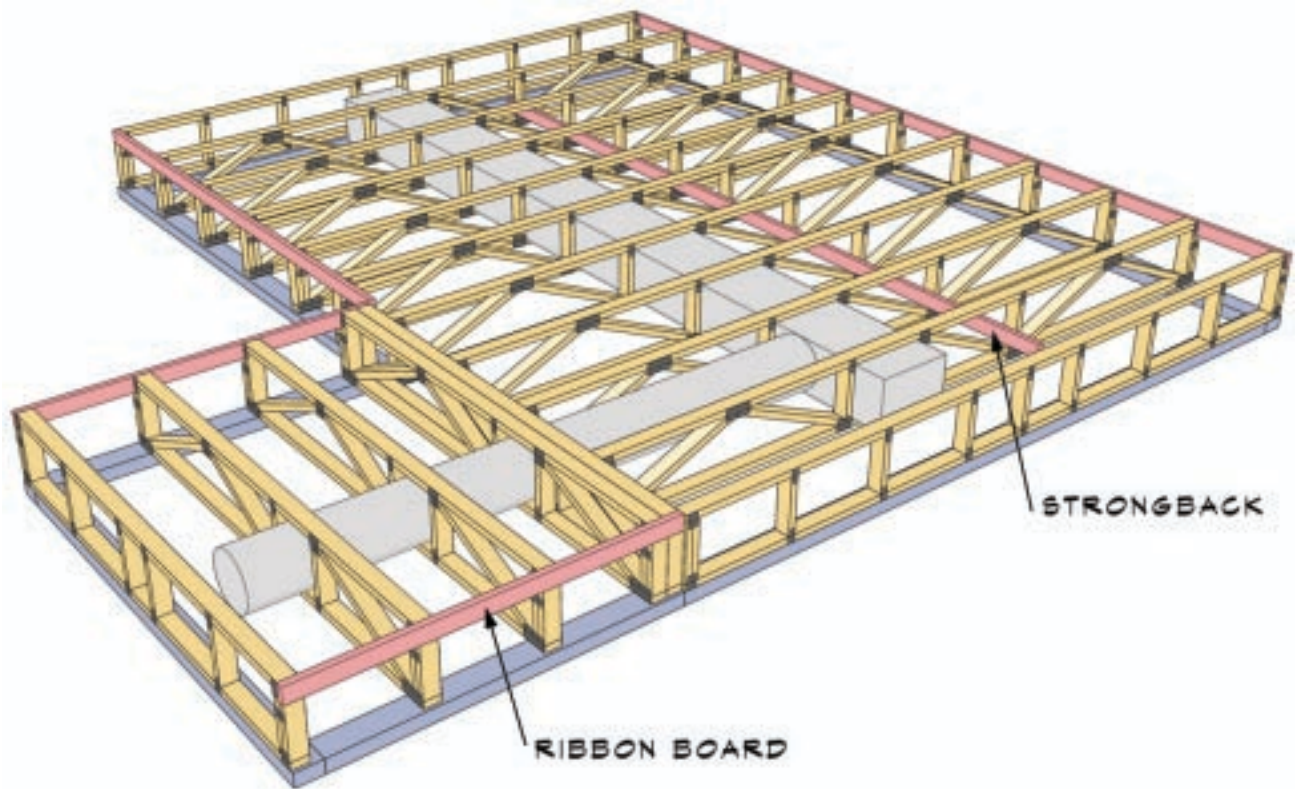
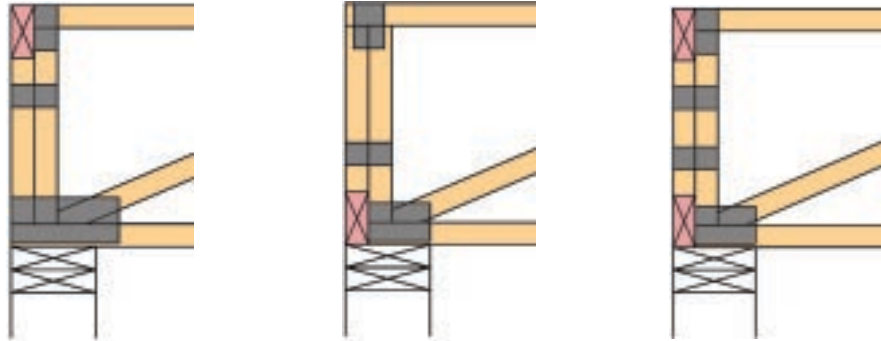

- **Strongbacks** – A strongback helps to distribute the loads on a floor truss, thereby helping reduce the “bounce” the floor system might otherwise have. Strongbacks are typically specified every 10’ to 11’ across a floor truss. As you can see in the image above, a strongback has been attached to the verticals of the longer floor trusses.
- **Fire Cut Ends** – In some cases, floor systems will be required to keep the top chord of the truss back away from the end wall. In such circumstances, a firecut end can be provided, as shown here.

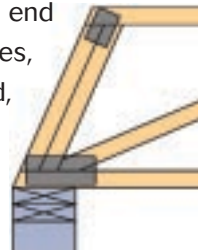

# Steel Trusses

While there are many steel truss solutions in the marketplace, Alpine's TrusSteel products are the best, providing:

- Lightweight trusses: One worker alone can typically lift a 35' truss by himself. TrusSteel trusses are easy to deliver, handle, and install.
- Meets fire code non-combustible materials requirements.

- Immune to insect damage, material deterioration and shrinkage, as well as from dry-wall nail pops.
- It's an engineered product, so you can build with confidence!
- The material is stiff, so installing drywall or other ceiling materials is easier.

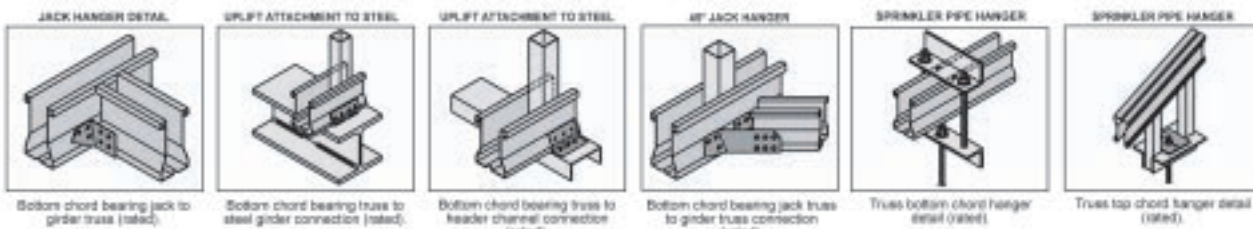
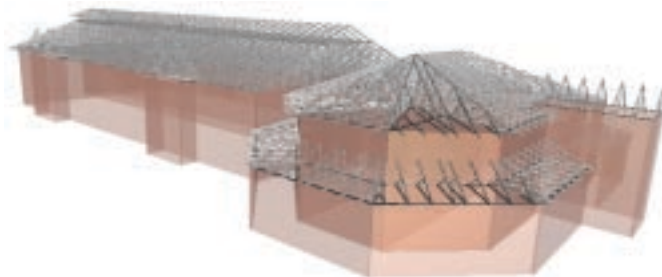

## Ask Charlie V.

For nearly 46 years, Charlie Vaccaro has worked in virtually every phase of the truss industry. Originally an aeronautical engineer, he has designed truss connector plates and trusses, started truss plants, and as been an Alpine production consultant since 1970. Today, he serves as a speaker, author and National Sales and Plant Consultant for Alpine Engineered Products, Inc.



*Strength-wise, what is the difference between conventional framing and trusses? Isn't conventional framing as strong?*

CV: It should be, but, how do you know? Trusses are designed with 2 to 3 times the design load. They are calculated and tested to perform at that level. The conventional framing depends on how good the carpenter in charge of the framing is. The only thing he knows about loading is what's been done in the past from a skilled carpenter. Most don't have formal training today.

*Why use trusses?*

CV: Trusses offer virtually unlimited architectural versatility - complete flexibility of interior partitioning and room arrangement - uniformity and accuracy from one truss to the next - faster and easier erection time - lightweight (generally 20 to 40 percent less than most other structural systems) - open web design - durable. They have a proven performance record - inspectable and "total in-place cost" savings.

Esthetically, I can take one basic floor plan and leave it exactly the same. Yet, from the outside, I can make it look like four different

• floor plans, just by changing the trusses. The only  
• cost difference is the trusses, not the floor plan. I  
• am only showing you four; but, with imagination, I  
• can do a few more elevations.

• If I have the resources, I can virtually work all  
• winter on homes by building the outside shell of  
• the house in fair weather, and work on the inside  
• during inclement weather and get a good day's  
• work done. If I was conventionally framing, my  
• days would be more subject to the elements.

• Most people with construction loans don't get to  
• their first draw until the roof is dried in. Trusses will  
• get you there weeks ahead of conventional  
• framing.

• With trusses, if the square foot of the floor plan is  
• the same, no matter what I do to the floor plan, my  
• cost difference would be the cost of adding or  
• deleting a wall. Since trusses can span longer  
• distances than conventional framing, I don't often  
• rely on interior load bearing walls, so you can  
• make changes to the interior without major  
• problems. Plus, I can create heavy storage areas  
• above the ceiling if needed, without changing the  
• floor plan.

• *Is it OK to cut a truss in the field?*

• CV: Structural members of a truss should never  
• be field cut without proper field repair



engineering from the truss manufacturer. Non-structural members, such as overhangs or filler bottom chords may be cut as long as they do not interfere with the structural integrity of the truss.

*What is temporary bracing?*

CV: Temporary bracing is described as bracing in WTCA and TPI's BCSI 1-03 as bracing which is installed to hold the trusses true to line, dimensions, and plumb. In addition, temporary bracing holds the trusses in a stable condition until permanent truss bracing and other permanent components

such as roof or floor sheathing, joists, or purlins which contribute to the overall rigidity of the roof or floor are in place.

*What is permanent bracing?*

CV: Permanent bracing is bracing that will be installed in the roof system as a permanent part of the roof system. The most common is continuous lateral bracing which is a member placed and connected at right angles to a chord or web to prevent buckling under loads less than design loads. Other examples are T-braces, L-braces, etc.

## ENERGY HEELS

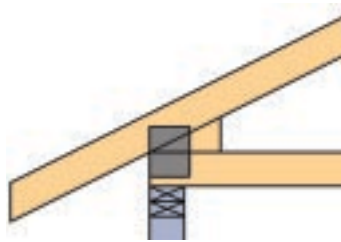

**SIMPLE**

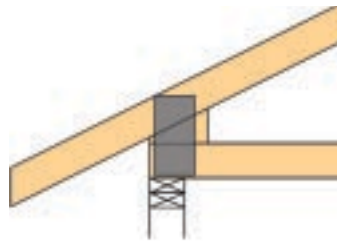

**STANDARD**

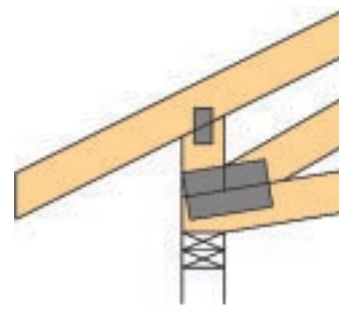

**12"**

*What are energy heels?*

CV: An energy heel is a truss with a raised heel to allow for proper ventilation with increased insulation at the wall line.

A simple energy truss is one where the top of the bottom chord just touches the bottom of the top chord, with a wedge plated on. This provides a raised heel of about 7-8 inches, depending on the pitch. This is the cheapest way to go.

A standard energy truss will typically have a set heel height, such as 8 or 10 inches. Typically, the end condition is made with a slider or a snubbed wedge.

A 12" energy heel provides for the most insulation and air flow. This is a good choice for scissors trusses so that a good amount of insulation can be applied; and, at the same

time, plenty of room is available for air flow. The most important issue, of course, is providing the proper air flow (ventilation) so that condensation is minimized. When the temperature difference between the insulation space and the attic is large, the potential for condensation is great. Wet insulation loses its "R" value. It is imperative that attics be well ventilated.

Typically, a baffle of cardboard or plastic is stapled to the sheathing between the trusses to allow a clear path for air to flow. The baffle extends a little beyond the wall line past the point where the insulation stops. On the inside, it extends along the pitch so that the outlet is above the insulation layer.

One thing that helps the condensation problem is a moisture barrier on the ceiling. This prevents the warm, moist air from escaping into the attic.

I've got to provide the truss manufacturer with information so they can match some existing trusses. What information will they need?

- CV: Your local truss manufacturer may already
- have a form to help you with this, but the
- one below is a good starter.

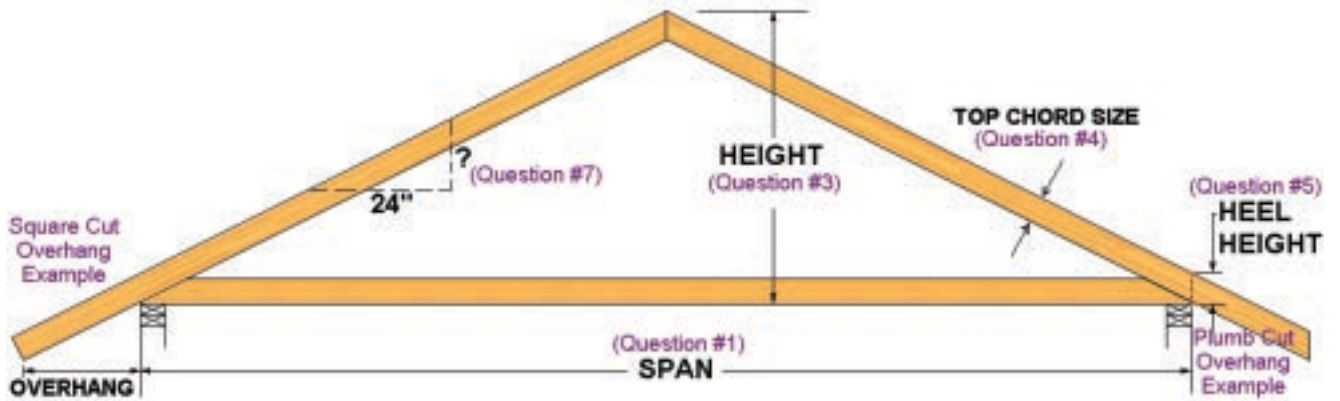

- 1) What is the Span of the truss? \_\_\_\_\_
- 2) Does the bottom chord of the truss run past the wall?    y    N                    (circle one)
  - a. If so, how far? \_\_\_\_\_
- 3) What is the Height of the truss? \_\_\_\_\_
- 4) What size is the top chord?    2x4    2x6    2x8    Not Sure                    (circle one)
- 5) What is the Heel Height? \_\_\_\_\_
- 6) Overhangs:
  - a. Put an overhang on    One Side    Both Sides    None                    (circle one)
  - b. Overhang length (measure horizontally) \_\_\_\_\_
  - c. Overhang type    Square Cut    Plumb Cut                    (circle one)

(Note: Truss shown has a Square Cut overhang on the left, and a Plumb Cut on the right)
- 7) Vertical rise for every 24" horizontal run, measured using a level? \_\_\_\_\_  
 (Please measure to within 1/8" accuracy)

Your Name: \_\_\_\_\_ Phone: \_\_\_\_\_

Best Time to Call: \_\_\_\_\_ Today's Date: \_\_\_\_\_

Any additional comments about this truss? \_\_\_\_\_

\_\_\_\_\_

Charlie's advice on situations to watch out for in the field:

- **No purlins, or no lateral bracing under field applied piggybacks** - You will need a braced system to keep the flat top chords of the hip trusses from bending out of plane (usually purlins, as shown in blue), plus some kind of bracing for those purlins (in red). Engineering firms familiar with wood and/or steel truss systems, such as the Alpine Structural Consultants, can assist in designing the right system.

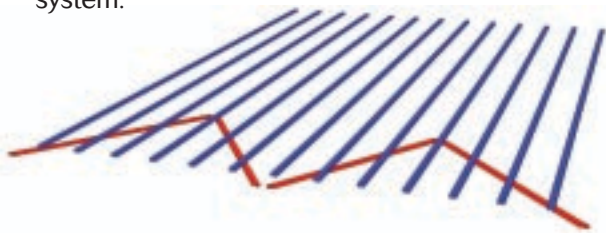

- **Missing web bracing** – If the truss drawing shows a web brace (CLB, T-Brace, L-Brace, Scab brace) and hasn't been applied, it needs to be applied! Refer to the truss drawing for brace size and connection information.
- **No decking under a valley set** – Remember that it is important to brace the top chords of the trusses under a valley set. Apply sheathing under the valley set, and attach the valleys well to that sheathing.
- **Leftover girders or other trusses on the ground** – If you have set all the trusses on the roof but there are still trusses on the ground, double check the truss placement plan, and call the truss manufacturer. You may have missed an extra girder ply, or they may have made a mistake. Either way, it's important to be confident that you have the roof system in place properly!

- **Deflecting girders, or incorrect fastening of girder/beam plies** – Multiple ply girders and beams MUST be fastened together BEFORE you put any loads on them!!! The truss drawing will provide instructions for the nail type you should use and the proper nail spacing for each member (Top chords, bottom chords, and webs). Also, if a bearing block is specified on any truss, be sure to install it!
- **Trusses installed backwards or upside down** – For any truss that could possibly be installed upside down, or backwards, take time to look at the truss drawings and find out how it was designed to be installed. If you have installed a truss backwards or upside down, either re-install it properly, or call the truss manufacturer ASAP to work together to resolve the problem.
- **Lumber grade markings** – Trusses are built with special engineered lumber grades, and the wood is stamped with that grade marking. If you don't see those stamps on the wood, double check to see that it was built using the lumber grades and sizes specified on your engineered truss designs.
- **Missing plates, broken or cracked web members** – Sometimes during handling a plate can fall off, or a web will crack, or a sub-contractor can cut through a web to install electrical, etc. You should never cut a truss without consulting with the truss manufacturer. If you see any of these situations, contact your truss manufacturer for assistance in resolving these problems. Trusses are engineered to perform under designed loads, but they assume all the webs and chords are in good shape. Damage to a web or chord can require a repair (many times a simple repair for such conditions), in order for the roof to be structurally sound.



## Glossary of Terms

**AXIAL FORCE** - A push (compression) or pull (tension) force acting along the length of a member [usually measured in pounds (lbs)].

**AXIAL STRESS** - The axial force acting along the length of a member, divided by the cross-sectional area of the member [usually measured in pounds per square inch (psi)].

**BEARING** – Anything which supports a truss; usually walls, hangers, beams or posts (shown in blue below).

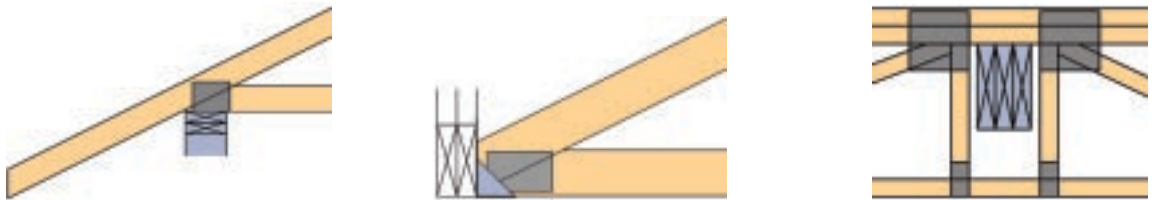

**BENDING MOMENT** - A measure of the bending effect on a member due to forces acting perpendicular to the length of the member. The bending moment at the given point along a member equals the sum of all perpendicular forces, either to the left or right of the point, times their corresponding distances from the point. Usually measured in inch-pounds.

**BENDING STRESS** - The force per square inch acting at a point along the length of a member, resulting from the bending moment applied at that point. Usually measured in pounds per square inch (psi).

**BOTTOM CHORD** - Horizontal or inclined members that establish the lower edge of a truss, usually carrying combined tension and bending stresses.

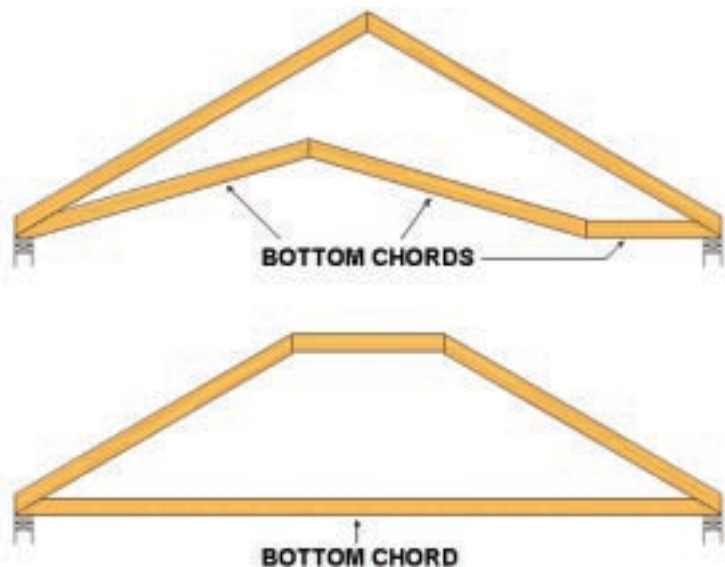

**BRACING** - See Lateral Bracing, Temporary Bracing, Permanent Bracing

**BUILT-UP BEAM** - A single unit composed of two or more wood members having the same thickness but not necessarily the same depth, which provides a greater load carrying capacity as well as greater resistance to deflection.

**BUTT CUT** - Slight vertical cut at outside end of truss bottom chord made to ensure uniform nominal span and tight joints. Usually 1/4-inch.

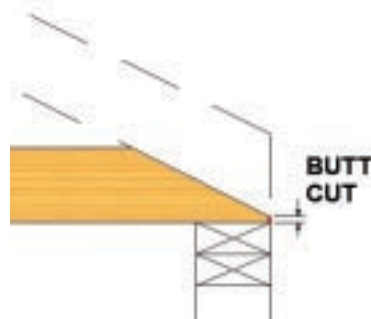

**CAMBER** - An upward vertical displacement built into a truss, usually to offset deflection due to dead load.

**CANTILEVER** - The part of a truss that extends beyond its support. The truss below has a cantilever on the right.

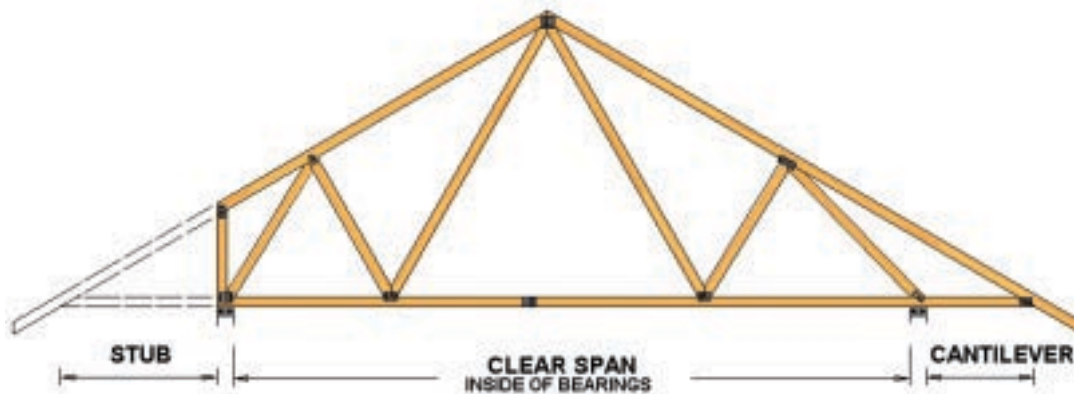

**CLEAR SPAN** - Horizontal distance between interior edges of supports (see image above).

**COMBINED STRESS** - The combination of axial and bending stresses acting on a member simultaneously, such as occurs in the top chord (compression + bending) or bottom chord (tension + bending) of a truss.

**CONCENTRATED LOAD** - An additional load centered at a given point. An example is a crane or hoist hanging from the bottom chord at a panel point or mechanical equipment supported by the top chord.

**DEAD LOAD** - Permanent loads that are constantly on the truss, i.e.: the weight of the truss itself, purlins, sheathing, roofing, ceiling, etc.

**DEFLECTION** - Downward or horizontal displacement of a truss due to loads.

**DIAPHRAGM** - A large, thin structural element that acts as a horizontal beam to resist lateral forces on a building.

**DRAG STRUT** - Typically a horizontal member, such as a truss or beam, which transfers shear from a diaphragm to a shear wall.

**DROPPED GABLE** – A gable truss that has its top chord lowered vertically to allow outlookers or a gable ladder to form an overhang.

**DURATION OF LOAD FACTOR** - An adjustment in the allowable stress in a wood member, based on the duration of the load causing the stress. The shorter the time duration of the load, the higher the percentage increase in allowable stress.

**ENERGY HEELS** – See page 39.

**HEEL** – The vertical height of the truss at the end of the span, measured from the top of the top chord to the bottom of the bottom chord.

**HIP SET** – A trussed system where three planes come in on a slope, so the outside planes look like this:

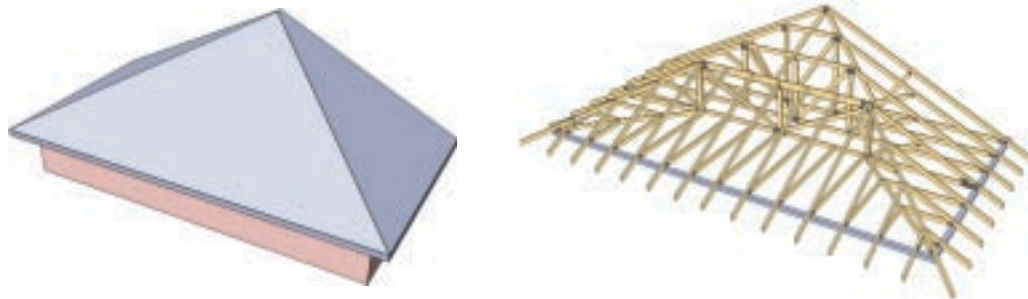

**GABLE END** – A truss with vertical studs, usually spaced 24" on center (or closer). The gable usually sits on an end wall and the studs help provide support for the sheathing and resistance to wind.

**LATERAL BRACING** - A member installed and connected at right angles to a chord or web member of a truss to resist lateral movement.



**LEVEL RETURN** - Lumber filler placed horizontally from the end of an overhang to the outside wall to form soffit framing.

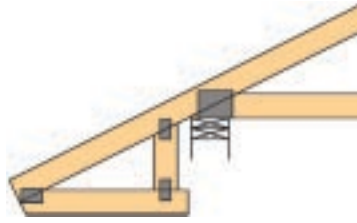

**LIVE LOAD** - Any load which is not of permanent nature, such as snow, wind, seismic, movable concentrated loads, furniture, etc. Live loads are generally of short duration.

**MID-HEIGHT BEARING** – A Mid-Height bearing condition is when the elevation of the bearing that supports the truss is above the bottom chord, and below the top chord enough to require a short vertical, which will run from the top chord to the bearing.

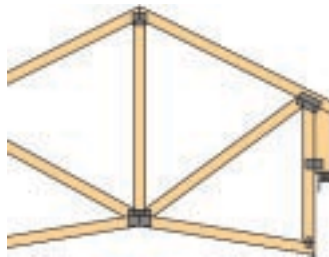

**OVERHANG** - The extension of the top chord (usually) or bottom chord of a truss beyond the support.

**PANEL** - The chord segment defined by two successive joints.

**PANEL LENGTH** - The centerline distance between joints measured along the chord.

**PANEL POINT** - The centerline of the point of intersection in a joint where a web(s) meets a chord.

**PEAK** - Point on a truss where the sloped top chords meet.

**PERMANENT BRACING** – Bracing put on a roof or floor system that is intended to remain permanently on the roof to reinforce the structure.

**PIGGYBACK** – A cap truss provided which will sit on top of the trusses below (with purlins and blocking), usually when the trusses are too tall to build, or too tall to deliver.

**PITCH** – The slope of the roof, usually expressed as the vertical rise measured over a run of 12" (so if the roof rises 6" vertically for every 12" inches horizontally).

**PLUMB CUT** - Top chord cut that is plumb to the building floor line provided for vertical installation of a fascia.

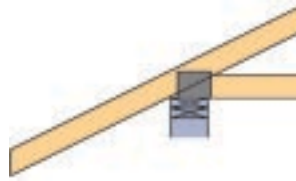

**PURLIN** - A horizontal member in a roof perpendicular to the truss top chord used to support the decking.

**REACTION** - Forces acting on a truss through its supports that are equal but opposite to the sum of the dead and live loads.

**RIBBON NOTCH** – See page 36..

**RIDGE** – A ridge is the line formed when two planes meet.

**SHEARWALL** - A wall element that acts as a large vertical beam, cantilevered from the foundation to resist lateral forces on the building.

**SLOPE (Pitch)** - The inches of vertical rise in 12 inches of horizontal run for inclined members, generally expressed as 3/12, 4/12 etc.

**SPAN** – The length of the truss, measured from outside bearing to outside bearing, except in the case of cantilever conditions. If the truss is cantilevered beyond an outside bearing, the Span length would include the length of the bottom chord beyond the outside wall.

**SPLICE (Top or Bottom Chord Splice)** - The point at which two chord members are joined together to form a single member.



**SQUARE CUT Overhang** - A cut perpendicular to the slope of the member at its end.

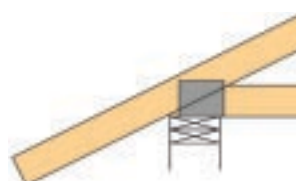

**STUB** – When the truss is held back from its original span.

**SYSTEM 42** – A truss (usually a flat truss) where the 2x4 members have been rotated 90 degrees onto their sides, resulting in a truss that is 3" wide instead of 1" wide. These trusses are usually used floor systems, but can be provided as roof trusses because you can achieve shallow depth trusses when you utilize System 42s. These trusses can sometimes be manufactured using 3x2 lumber instead of 4x2 lumber.

**TEMPORARY BRACING** – Bracing added to the roof or floor system to brace it during erection and installation.

**TOP CHORD** - An inclined or horizontal member that establishes the upper edge of a truss, usually carrying combined compression and bending stresses.

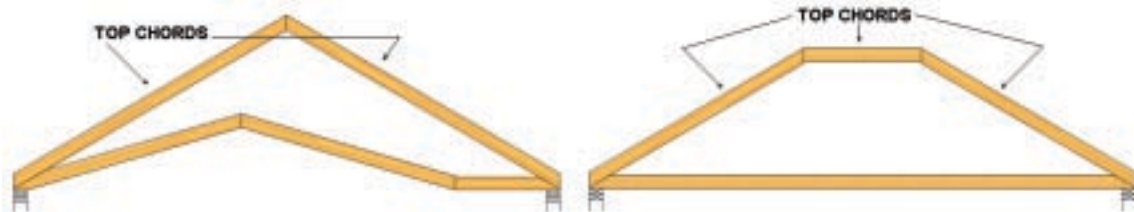

**TOP CHORD BEARING** – Any time the bearing rests directly under the top chord of the truss. The image on the right is also often referred to a "tail bearing" truss.

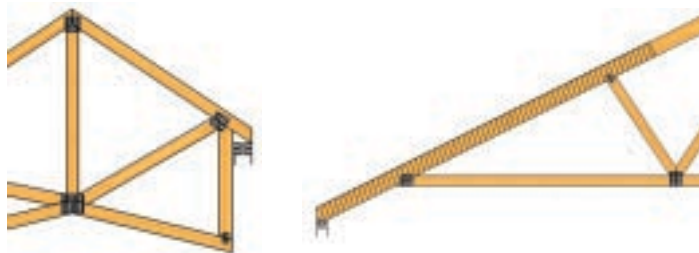

**TRUSS** - A manufactured component that functions as a structural support member. A truss employs one or more triangles in its construction.

**VALLEY SET** - Trusses built to change the look of the roof system, which sit in a perpendicular direction on top of other trusses.

**VIBRATION** - The term associated with the serviceability of a floor. If the occupant feels the floor respond to walking or other input, it may be referred to as vibration or response to load.

**WEBS** - Members that join the top and bottom chords to form the triangular patterns that give truss action, usually carrying tension or compression stresses (no bending).

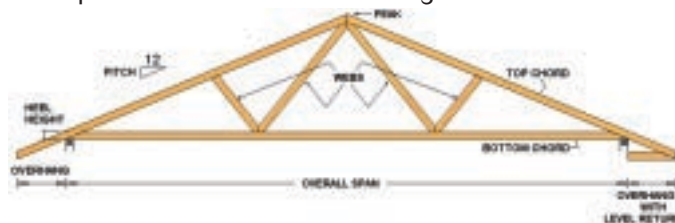

## Appendix B - References

### American Forest & Paper Association (AFPA)

- 202/463-2700 [www.afandpa.org](http://www.afandpa.org)  
1111 19th St. NW, # 700, Washington, DC 20036
- National Design Specification for Wood Construction (NDS)
  - Wood Frame Construction Manual

### American National Standards Institute (ANSI)

- 212/642-4900 [web.ansi.org](http://web.ansi.org)  
11 West 47th Street, New York, NY 10036
- See TPI

### APA - The Engineered Wood Association

- 206/565-6600 [www.apa.wood.org](http://www.apa.wood.org)  
1119 A Street, Tacoma, WA 98401
- Use of Rated Sheathing in Roofs & Floors
  - Fire Rated Systems
  - Diaphragm Design

### American Society of Civil Engineers (ASCE)

- [www.asce.org](http://www.asce.org)  
1801 Alexander Bell Dr., Reston, VA 20191-4400
- Minimum Design Loads for Buildings And Other Structures, ASCE7

### American Society for Testing and Materials (ASTM)

- [www.astm.org](http://www.astm.org)  
1916 Rice Street, Philadelphia, PA 19103
- Test Methods for Fire Tests for Building Construction and Materials, E-119

### Building Officials and Code Administrators International, Inc. (BOCA)

- 708/799-2300 [www.bocaresearch.com](http://www.bocaresearch.com)  
4051 W. Flossmoor Road, Country Club Hills, IL 60478

### The BOCA National Building Code Council of American Building Officials (CABO)

- 703/931-4533 [www.cabo.org](http://www.cabo.org)  
5203 Leesburg Pike, # 798, Falls Church, VA 22041
- One and Two Family Dwelling Code

### Forest Products Laboratory

- [www.fpl.fs.fed.us](http://www.fpl.fs.fed.us)  
U.S. Department of Agriculture  
One Gifford Pinchot Drive, Madison, WI 53705
- Wood Handbook: Wood as an Engineered Material

### Gypsum Association

- 202/289-5440 [www.gypsum.org](http://www.gypsum.org)  
810 First St. NE, # 510, Washington, DC 20002
- Fire Resistance Design Manual, GA-600

### International Code Council (ICC)

- 703-931-4533 [www.intlcode.org](http://www.intlcode.org)  
5203 Leesburg Pike, #600, Falls Church, VA 22041
- International Building Code
  - International Residential Code

### International Conference of Building Officials (ICBO)

- 213/699-0541 [www.icbo.com](http://www.icbo.com)  
5360 S. Workman Mill Rd, Whittier, CA 90601
- Uniform Building Code
  - Uniform Fire Code

### NAHB Research Center

- 301-249-4000 [www.nahbrc.org](http://www.nahbrc.org)  
400 Prince Georges Blvd., Upper Marlboro, MD 20774

### National Frame Builders Association (NFBA)

- 913/843-2111 [www.postframe.org](http://www.postframe.org)  
4980 W. 15th St., # 1000, Lawrence, KS 66049
- Post Frame Building Design
  - Post Frame Comes of Age
  - Recommended Practices-Post Frame Construction

### Southern Forest Products Association (SFPA)

- 504/443-4464 [www.southernpine.com](http://www.southernpine.com)  
P. O. Box 64700, Kenner, LA 70064
- Southern Pine Maximum Spans for Joists and Rafters
  - Southern Pine Use Guide

### Southern Building Code Congress International, Inc. (SBCCI)

- 205/591-1853 [www.sbcci.org](http://www.sbcci.org)  
900 Montclair Road, Birmingham, AL 35213-1206
- Standard Building Code
  - Wind Design Standard, SSTD 10-93

### Truss Plate Institute (TPI)

- 608/833-5900 [www.tpinst.org](http://www.tpinst.org)  
583 D'Onofrio Drive, Suite 200, Madison, WI 53719
- National Design Standard for Metal Plate Connected Wood Truss Construction, ANSI/TPI 1-2002
  - Standard for Testing Metal Plate Connected Wood Trusses, ANSI/TPI 2-1995
  - Recommended Design Specification for Temporary Bracing of MPC Wood Trusses, DSB-89

### Western Wood Products Association (WWPA)

- 503/224-3930 [www.wwpa.org](http://www.wwpa.org)  
533 SW Fifth Ave., Portland, OR 97204
- Western Lumber Product Use Manual

### Wood Truss Council of America

- 608/274-4849 [www.woodtruss.com](http://www.woodtruss.com)  
One WTCA Center  
6300 Enterprise Ln., Madison, WI 53719
- Metal Plate Connected Wood Truss Handbook
  - Job-Site Bracing Poster - TTB Series
  - ANSI/TPI/WTCA 4-2002
  - Building Component Safety Information BCSI 1-03

## Canadian References

### Alpine Systems Corporation

- 905/879-0700 [www.alpeng.com](http://www.alpeng.com)  
70 Moyal Court, Concord, ON L4K 4R8
- Truss Design Procedures and Specifications for Light Metal Plate Connected Wood Trusses (Limit States Design), published by TPIC

### Canadian Wood Truss Association - L'Association

- Canadienne des Fabricants de Fermes de Bois**  
613/747-5544 [www.cwc.ca](http://www.cwc.ca)  
1400 Blair Place, Suite 210, Ottawa, ON K1J 9B8
- Wood Design Manual

### Canadian Standards Association

- 416/747-4044 [www.csa.ca](http://www.csa.ca)  
178 Rexdale Boulevard • Rexdale, ON M9W 1R3
- CSA 086.194 "Engineering Design in Wood (Limit States Design)"
  - CSA S347-M1980 "Method of Test for Evaluation of Truss Plates Used in Lumber Joints"

### National Research Council of Canada

- 613/993-2463 [www.nrc.ca/irc](http://www.nrc.ca/irc)  
Institute for Research in Construction  
1500 Montreal Road • Ottawa, ON K1A 9Z9
- National Building Code of Canada (NBCC)
  - National Farm Building Code of Canada (NFBC)

## Light Gauge Steel References

### Light Gauge Steel Engineers Association

- 866/465-4732 [www.lgsea.com](http://www.lgsea.com)  
1201 15th Street, N.W., Suite 320, Washington, DC 20005
- Field Installation Guide for CFS Roof Trusses
  - Design Guide: Permanent Bracing of CFS Steel Trusses